

Prof. M. N. Navale
M.E. (Elect.) MIE, MBA
Founder President

Dr. (Mrs.) Sunanda M. Navale
B.A., M.P.M., Ph.D.
Founder Secretary

Dr. Rajashree Shinde
M.Com., M.Ed., M.P.M., FDP(MIIMA), Ph.D.
Director

1. List of extension and outreach Programs conducted during the year (2019-20): -

Sr. No.	Name of the extension and outreach programme conducted	No. of Students Participated	Page No.
1	Green Earth (Tree Plantation)	20	1
2	Corporate Roadies	48	4
3	Flood Relief Donation	20	10
4	Sinhgad Karandak	510	18
5	Marketing Seminar	115	95
6	Induction Program 2019	220	101
7	Women's Day	19	107
8	Road Safety Awareness	180	111
9	Marathi Bhasha Pandharwada	100	114

REPORT OF TREE PLANTATION PROGRAM 2019

Date : 19th August 2019

Venue: STES Vadagaon Campus Bus Parking

Co-ordinators : Dr.SadhanaOgale Prof. MayuriYadav

On 19th August 2019, SKNSSBM, successfully completed the event of Tree Plantation at college campus. Trees are the foremost source for producing the oxygen in environment, they helps to reduce the level of carbon dioxide. As we all know that the whole world is facing the problem of global warming and to recover from such problem planting the trees is become one of the most important aspects today.

Director, Dr Rajashree Shinde along with all faculty members and 100 students planted 26 saplings in College campus. These saplings include different types of trees which is having great capacity to generate oxygen. Non teaching Staff also took initiative in plantation drive.

All were happy and experience proud after the tree plantation event, as it gave great feeling to do positive for the nature.

Photographs of Event:



Director

S.K.N. Sinhgad School of Business Management
S. No. 10/1, Ambegaon (BK), Pune - 411 041





S.K.N.
Director

S.K.N. Sinhgad School of Business Management
S. No. 10/1, Ambegaon (BK), Pune - 411 041





Director

S.K.N. Shiksha School of Business Management
S. No. 10/1, Ambegaon (BK), Pune - 411 041



Report of Corporate Roadies Event

Venue: SKNSSBM S9 and S10

Date: 7th February 2020

Time: 10.00 am to 01.30 pm

Coordinator: Prof Mayuri Yadav & Prof. Kalpana Sayankar

Under Sinhgad Karandak Spectrum 2020 Corporate Roadies event was organized by S.K.N.SINHGAD SCHOOL OF BUSINESS MANAGEMENT in S9 and S10 Classroom on 7th February 2020. After the inauguration the coordinators explained rationale and rules of the game.

In the game there were 5 rounds viz 1. Typing master, 2. Rapid fire, 3. Brain Teasing and Concentration game, 4. Management game -What's on your Desk? 5. Case study competition. Total 12 teams participated in the event. Each team consisted of 4 participants. Judges for this event were Mr. Rohit Jamdade and Mr. Sajal Rajak who are industry experts.

In the first round i.e. Typing Master one student from each team participated. Students were judged on the basis of their typing speed and accuracy. 2 teams were eliminated in this round.

In the second round i.e. Rapid fire questions were asked related to general knowledge. The teams were judged on the basis of maximum rapid answers. 2 teams were eliminated in this round.

In the third round i.e. Brain teasing and concentration game. One student from each team participated. In this game students were judged on the basis of their concentration and accuracy, while playing that game. 3 teams were eliminated in this round.

In the fourth round i.e. Management game -What's on your Desk? The specific item selected by students as a 'product' for selling. After 15 minutes discussion they came up with name, slogan and marketing plan for the object. In this round students were judged on the basis of idea, presentation skill. 2 teams were eliminated in this round.

In the fifth round i.e. Case Study Competition. Teams analyzed a business case study. In this round students were judged on the basis of best solutions offered for that case. One team was eliminated in this round and one team was declared as runner up and one team was declared as winner of Corporate Roadies.

During this activity all the participants enjoyed the most and this event gives them a chance to show their management skills, talent, team work abilities and activeness.

Details of the participation of the students:

Year	Activity	Number of participants
2020	Corporate Roadies	48

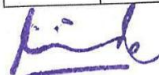

Director

S.K.N. Sinhgad School of Business Management
S. No. 10/1, Ambegaon (BK), Pune - 411 041



Photos of Event:



Inauguration

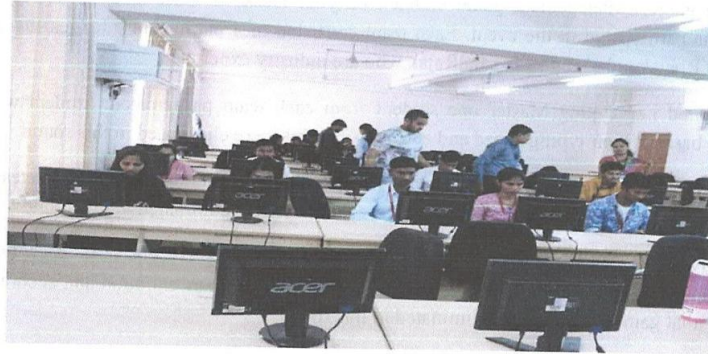

First Round: Typing Master



Second Round: Rapid Fire

Kishor
Director

S.K.N. Sinhgad School of Business Management
No. 10/1, Ambegaon (BK), Pune - 411 041



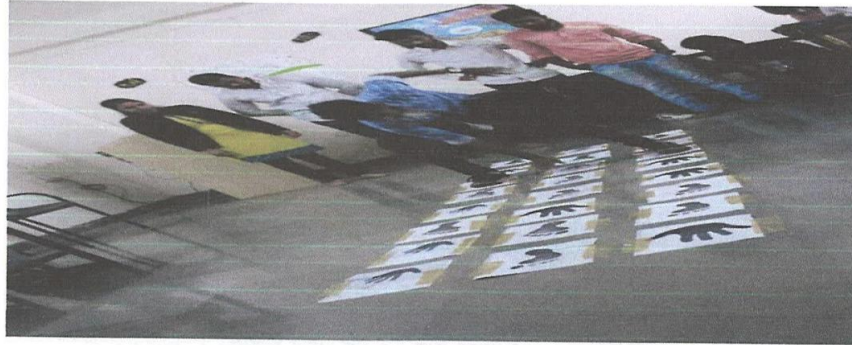

Third Round: Brain teasing and concentration game



Fourth Round: Management game -What's on your Desk?

[Handwritten signature]

Director

S.K.N. Sinhgad School of Business Management
S. No. 10/1, Ambegaon (BK), Pune - 411 041



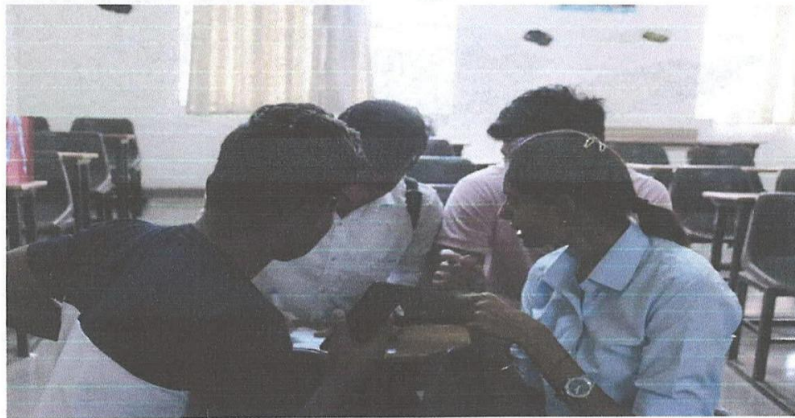

Fifth round i.e. Case Study Competition



Runner up Team

Director

S.K.N. Sinhgad School of Business Management
S. No. 10/1, Ambegaon (BK), Pune - 411 041





Winner Team

Director

S.K.N. Sinhgad School of Business Management
S. No. 10/1, Ambegaon (BK), Pune - 411 041





Date: 26/August/2019

To ,
The Director,
SKN Sinhgad School of Business Management
AmbegaonPune .

Respected Madam,

We SKNSSBM students and faculty would like to conduct CSR Activity- Flood Relief Donation activity for Sangali and Kolhapur flood affected area .Kindly permit us to conduct the activity in college premises.

Activity Date and Venue:

Date: 27th and 28th August 2019

Venue : Ground Floor , S.K.N. Sinhgad School of Business Management

Thanking You,

Regards,

Faculty Activity Coordinator:

Dr.Sadhana Ogale

Prof. Mayuri Yadav

Student Activity Coordinator :

Mr.Shubham Pakave

Mr.Harshvardhan Vyas

Mr.Abhijit Hamane



S.K.N.Sinhgad School of Bussiness Management,Ambegaon (Bk)

[Signature]
Director

S.K.N. Sinhgad School of Business Management
S. No. 10/1, Ambegaon (BK), Pune - 411 041

Report on CSR Activity – Flood Relief Donation Activity

Date: 27th and 28th August 2019

Venue: Ground Floor, S.K.N. Sinhgad School of Business Management,
Ambegaon (Bk), Pune

Coordinators: Dr. Sadhana Ogale, Prof. Mayuri Yadav

With the onset of the monsoon in early August 2019, Sangli and Kolhapur continues to be lashed by heavy rainfall causing widespread flooding and displacement in the state. Many people from nearby villages have been affected. Several villages submerged and thousands of homes and acres of farmland destroyed. Residents of temporary shelters and those who are returning to their partially submerged villages battle a lack of safe drinking water, basic needs for survival, sanitation and hygiene facilities.

S.K.N. Sinhgad School of Business Management planned flood relief donation activity on 27th and 28th August 2019 for flood affected families in Sangli and Kolhapur. In this activity vulnerable people received survival things like grocery for one month and steel tins and pans. SKNSSBM students personally reach to the 25 flood affected families and hand over material collected during the activity by college.



hinde

Director

S.K.N. Sinhgad School of Business Management
S. No. 10/1, Ambegaon (BK), Pune - 411 041





Director
S.K.N. Shiksha School of Business Management
S. No. 10/1, Ambegaon (BR), Pune - 411 041





hish
Director
S.K.N. Singhad School of Business Management
S. No. 10/1, Ambegaon (BK), Pune - 411 041



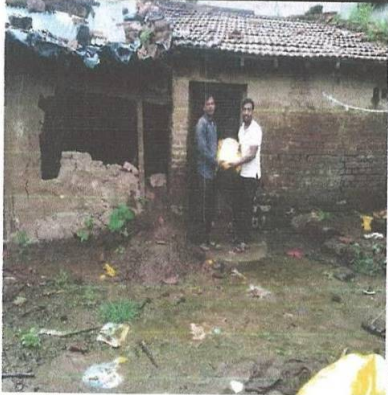
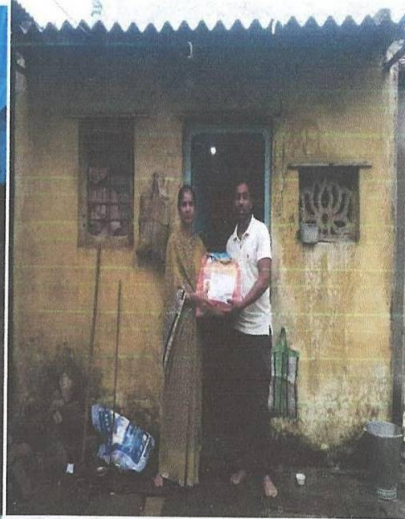

K. N. Singh

Director

S.K.N. Sinhgad School of Business Management
S. No. 10/1, Ambeganga (BK), Pune - 411 041





Director

S.K.N. Sinhgad School of Business Management
S. No. 10/1, Ambegaon (PK), Pune - 411 041





Kishor

Director

S.K.N. Shriyad School of Business Management
S. No. 10/1, Airobagach (PK), Pune - 411 041



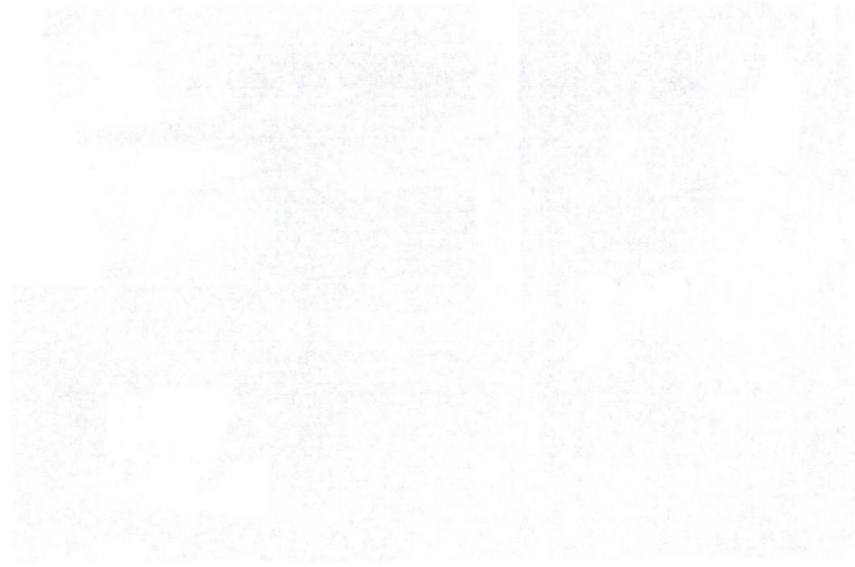



Sinhgad Institutes

12/12
SINHGAD TECHNICAL EDUCATION SOCIETY®

(Regd. No. MAH / 7199-93 / Pune dt. 6/7/93 & F-8282 (Pune) dt. 12/8/93)

S. No. 44/1, Vadgaon (Budruk), Off Sinhgad Road, Pune - 411 041.
Tel. / Fax : (020) 2435 4721 Email : stes@sinhgad.edu Website : www.sinhgad.edu

PROF. M. N. NAVALE
M.E. (ELECT.) MIE., MBA.
FOUNDER PRESIDENT

DR. (MRS.) SUNANDA M. NAVALE
B.A., MPM, Ph.D.
FOUNDER SECRETARY

STES/2019-20/3186

Date: 12 Dec. 2019

To,
All Principal/Directors,
STES.

The Sinhgad Karandak 2020 schedule is revised in view of the revised SPPU academic calendar for FE and MBA programmes. The details are as follows:

1. Intercampus and Inter Collegiate final round of Sinhgad Karandak NEON 2020 will be held at Vadgaon Campus from 5th February 2020 to 8th February 2020, details regarding the same are attached herewith.
2. Preliminary round of all the NEON 2020 events will be held from 20th January 2020 to 22nd January 2020 at various campuses, details regarding the same are attached herewith.
3. Sinhgad Karandak Techtonic 2020 will be held from 6th February 2020 to 8th February 2020, Sinhgad Karandak Spectrum 2020 will be held from 7th February 2020 to 8th February 2020.
4. Sinhgad Sports Karandak 2020 will be held during 7th January 2020 to 31st January 2020.

Dr. (MRS.) SUNANDA M. NAVALE
FOUNDER SECRETARY, STES &
SECRETARY, SINHGAD CULTURAL CENTRE,
STES, PUNE



Director

S.K.N. Sinhgad School of Business Management
S. No. 10/1, Ambegaon (BK), Pune - 411 041

Scanned by CamScanner

SINHGAD KARANDAK - NEON 2020

Day - Wise Summary

Sr. No.	Date & Day	Events	Inter Campus Teams + Inter College Teams	Time of Event	Venue
1	05/02/2020 Wednesday	Mr and Miss Sinhgad	9+9=18	04.15 PM to 5.15 PM	Cultural Centre (Vadgaon Campus)
		Fashion Show	9+9=18	05.15 PM to 08.15 PM	Cultural Centre (Vadgaon Campus)
2	06/02/2020 Thursday	Sinhgad Idol Solo Singing	9+9=18	04.00 PM to 06.00 PM	Cultural Centre (Vadgaon Campus)
		Sinhgad Idol Duet Singing	9+9=18	06.00 PM to 8.00 PM	Cultural Centre (Vadgaon Campus)
3	07/02/2020 Friday	Solo Dance	9+9=18	04.00 PM to 05.30 PM	Cultural Centre (Vadgaon Campus)
		Group Dance	9+9=18	05.30 PM to 8.00 PM	Cultural Centre (Vadgaon Campus)
4	08/02/2020 Saturday	Stage Play	9+9=18	04.00 PM to 8.30 PM	Cultural Centre (Vadgaon Campus)
		Aegis of Rock	9	08.30 PM to 10.15 PM	Cultural Centre (Vadgaon Campus)

Scanned by CamScanner

Mr. Rohit M. Navale
 Vice - President (HR), STES &
 Chairman (Sinhgad Cultural Centre)
 Director
 STES, Pune

S.K.N. Sinhgad School of Business Management
S. No. 10/1, Ambegaon (D), Pune - 411 041



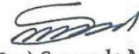

Dr. (Mrs.) Sunanda M. Navale
 Founder Secretary, STES &
 Secretary (Sinhgad Cultural Centre)
 STES, Pune

SINHGAD KARANDAK - NEON 2020

Date & Day	Sr No	Events	Campus Name	Inter Campus Teams + Inter College Teams	Time Allotted	Total Duration		Venue	Time of Event
						Minutes	Hours		
05/02/2020 Wednesday	1	Mr and Miss Sinhgad	Inter College & Inter Campus	9+9 = 18	3 Mins	54	00 Hrs 54 Mins	Cultural Center (Vadgaon Campus)	04.00 PM to 05.00PM
	2	Fashion Show	Inter Campus & Intercollege	9+9 = 18	9 Mins	162	02 Hrs 42 Mins	Cultural Center (Vadgaon Campus)	05.00 PM to 08.00PM
06/02/2020 Thursday	1	Sinhgad Idol Solo Singing	Inter Campus & Intercollege	9+9 = 18	6 Mins	108	01 Hr 48 Mins	Cultural Center (Vadgaon Campus)	04.00 PM to 05.48 PM
	2	Sinhgad Idol Duet Singing	Inter Campus & Intercollege	9+9 = 18	6 Mins	108	01 Hr 48 Mins	Cultural Center (Vadgaon Campus)	06.00 PM to 07.50 PM
07/02/2020 Friday	1	Solo Dance	Inter College & Inter Campus	9+9 = 18	4 mins	72	01 Hr 12 Mins	Cultural Center (Vadgaon Campus)	04.00 PM to 05.12PM
	2	Group Dance	Inter College & Inter Campus	9+9 = 18	6 mins	108	01 Hr 48 Mins	Cultural Center (Vadgaon Campus)	05.30 PM to 07.15PM
08/02/2020 Saturday	1	Stage Play	Inter College & Inter Campus	9+9 = 18	15 mins	270	04 Hrs 30 Mins	Cultural Center (Vadgaon Campus)	04.00 PM to 08.30 PM
	2	Aegis of Rock	Mix	9	15 mins	270	02 Hrs 15 Mins	Cultural Center (Vadgaon Campus)	08.30 PM to 10.15 PM

Note: Draw will be drawn to finalize sequence of all teams.

Scanned by CamScanner

Mr. Rohit M. Navale
 Vice - President (HR), STES &
 Chairman (Sinhgad Cultural Centre)
 STES, Pune

S.K.N. Sinhgad School of Business Management
S. No. 10/1, Ambegaon (D), Pune - 411 041





Dr. (Mrs.) Sunanda M. Navale
 Founder Secretary, STES &
 Secretary (Sinhgad Cultural Centre)
 STES, Pune

Circular
SINHGAD KARANDAK -NEON 2020

Work Responsibilities

This is to inform to the concerned Principals/Directors of the following institutes to note the responsibilities allotted for and ensure to shoulder the same with full capacity and strength.

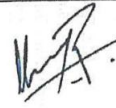
Sr. No.	Responsibility Details	Name of Responsible Institute/s/Person
1	Live in Concert (Back Stage & On stage)	Sinhgad College of Engineering (SCOE), Vadgaon campus (only staff)
2	Stage Play	1) Sinhgad Institute of Management (SIOM), Vadgaon Bk. Campus 2) Sinhgad Institute of Technology and Science (SITS), Narhe campus
3	Sinhgad Idol (Solo & Duet)	Sinhgad Idol Solo : 1) Sinhgad College of Science (SCOS), Ambegaon Bk. Campus 2) Sinhgad Institute of Business administration and Reserch (SIBAR) Kondhwa Campus Sinhgad Idol Duet : 1) Sou. Venutai Chavan Polytechnic (SVCP) Ambegaon Bk Campus 2) Sinhgad Institute of Management and Computer Application (SIMCA), Narhe Campus
4	Solo & Group Dance	Solo Dance: 1) Sinhgad College of Pharmacy (SCOP) Vadgaon Bk Campus 2) Sinhgad College of Arts, Science and Commerce, Narhe Campus Group Dance: 1) NBNSinhgad Technical Institute Campus (NBNSTIC) Ambegaon Bk. Campus 2) Sinhgad Academy of Engineering (SAE), Kondhwa Campus
5	Mr. & Miss Sinhgad	1) Sinhgad College of Architecture (SCOA), Vadgaon Bk Campus 2) RMD Sinhgad Technical Institute Campus, Warje
6	Sinhgad Fashion Show	1) Smt. Kashibai Navale College of Engineering (SKNCOE), Vadgaon Campus 2) Smt. Kashibai Navale Sinhgad School of Business Management (SKNSSBM), Ambegaon Bk. Campus
7	Aegis of Rock & Performance of top 3 bands	Main Coordinator - Prof. Nishad Patki (SCOE, Civil Dept.) & Faculty of Sinhgad Law College (SLC)
8	Arrangement of Judges (Vadgaon)	Respective final round event Organizing Colleges/Institutes
9	Trophies' Selection and purchase	Sinhgad College of Pharmacy (SCOP) Vadgaon Bk Campus
10	All Backdrops - Display, Print Promotional material, Certificates	Sinhgad Business School (SBS), Erandawane (Dr. Dhananjay Mandlik)
11	Inauguration	Sinhgad College of Engineering (SCOE), Vadgaon Bk. Campus
12	Hospitality (Entire Karandak)	Sinhgad Institute of Management (SIOM), Vadgaon Bk. Campus (Excluding Live in Concert)
13	Discipline	1) Smt. Kashibai Navale College of Architecture, Ambegaon Bk. Campus 2) Sou. Venutai Chavan Polytechnic (SVCP), Ambegaon Bk. 3) Smt. Kashibai Navale College of Engineering (SKNCOE), Vadgaon Campus
14	Stalls - Allotment, coordination	Sinhgad College of Architecture (SCOA) Vadgaon Campus
15	International Students Coordination	Prof. Jayesh Minase (Head - Center for International Students)
16	Sponsorship Committee	All Institutes (Central Team) Head of Committee - Dr. S. S. Shastri (HOD-Civil) - Sinhgad College of Engineering, Vadgaon Campus

Mr. Rohit M. Navale
Vice - President (HR), STES &
Chairman (Sinhgad Cultural Centre)
STES, Pune

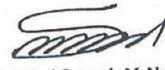
Dr. (Mrs.) Sunanda M. Navale
Founder Secretary, STES &
Secretary (Sinhgad Cultural Centre)
STES, Pune

Director

S.K.N. Sinhgad School of Business Management
S. No. 10/1, Ambegaon (BK), Pune - 411 041



Scanned by CamScanner



Sinhgad Technical Education Society's

SINHGAD SPORTS KARANDAK 2020



Lawn Tennis (Boys)

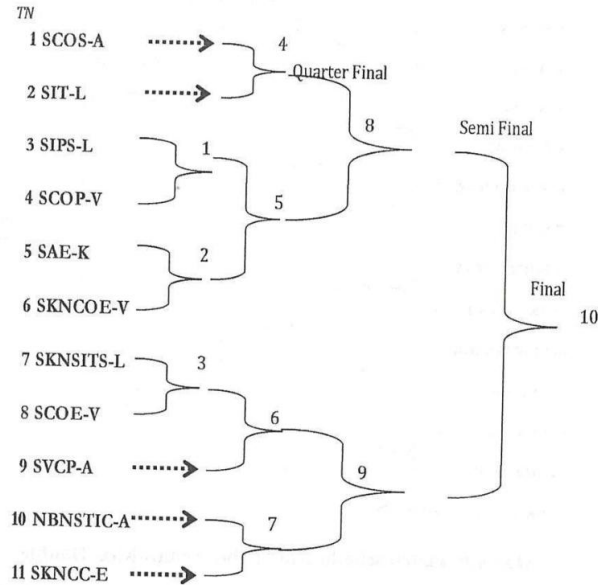

Match to match schedule for Lawn Tennis (Boys)

Match No.	Date	Time	Winner
First Round			
1	13/01/2020	10.00 am to 10.30 am	
2	13/01/2020	10.30 am to 11.00 am	
3	13/01/2020	11.30 am to 12.00 pm	
Quarter Final Matches			
4	13/01/2020	12.00 pm to 12.30 pm	
5	13/01/2020	1.30 pm to 2.00 pm	
6	13/01/2020	2.00 pm to 2.30 pm	
7	13/01/2020	2.30 am to 3.00 am	
Semi Final Matches			
8	14/01/2020	10.00 am to 11.00 am	
9	14/01/2020	11.00 am to 12.00 pm	
Final Match			
10	14/01/2020	1.00 pm to 2.00 pm	

Director

S.K.N. Sinhgad School of Business Management
 S. No. 10/1, Ambegaon (BK), Pune - 411 041





Sinhgad Technical Education Society's



SINHGAD SPORTS KARANDAK 2020

Table Tennis Mix - Double

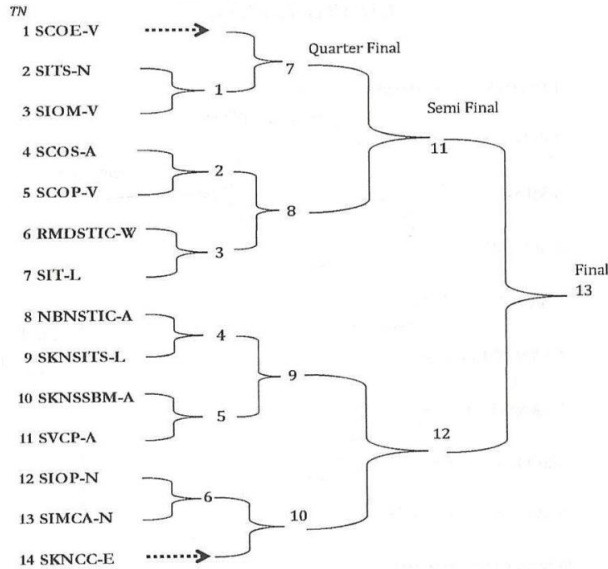

Match to match schedule for Table Tennis Mix- Double

Match No.	Date	Time	Winner
First Round			
1.	17/01/2020	10.00 am to 10.30 am	
2.	17/01/2020	10.00 am to 10.30 am	
3	17/01/2020	10.30 am to 11.00 am	
4	17/01/2020	10.30 am to 11.00 am	
5	17/01/2020	11.00 am to 11.30 am	
6	17/01/2020	11.00 am to 11.30 am	
Quarter Final Matches			
7	17/01/2020	11.30 am to 12.00 pm	
8	17/01/2020	11.30 am to 12.00 pm	
9	17/01/2020	12.00 pm to 12.30 pm	
10	17/01/2020	12.00 pm to 12.30 pm	
Semi Final Matches			
11	17/01/2020	1.30 pm to 2.00 pm	
12	17/01/2020	1.30 pm to 2.00 pm	
Final Match			
13	17/01/2020	2.30 pm to 3.00 pm	

34

Handwritten signature
Director

S.K.N. Sinhgad School of Business Management
S. No. 10/1, Ambegaon (BK), Pune - 411 041

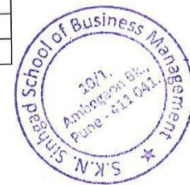



Sinhgad Technical Education Society's
SINHGAD SPORTS KARANDAK 2020



Table Tennis Double (Boys)

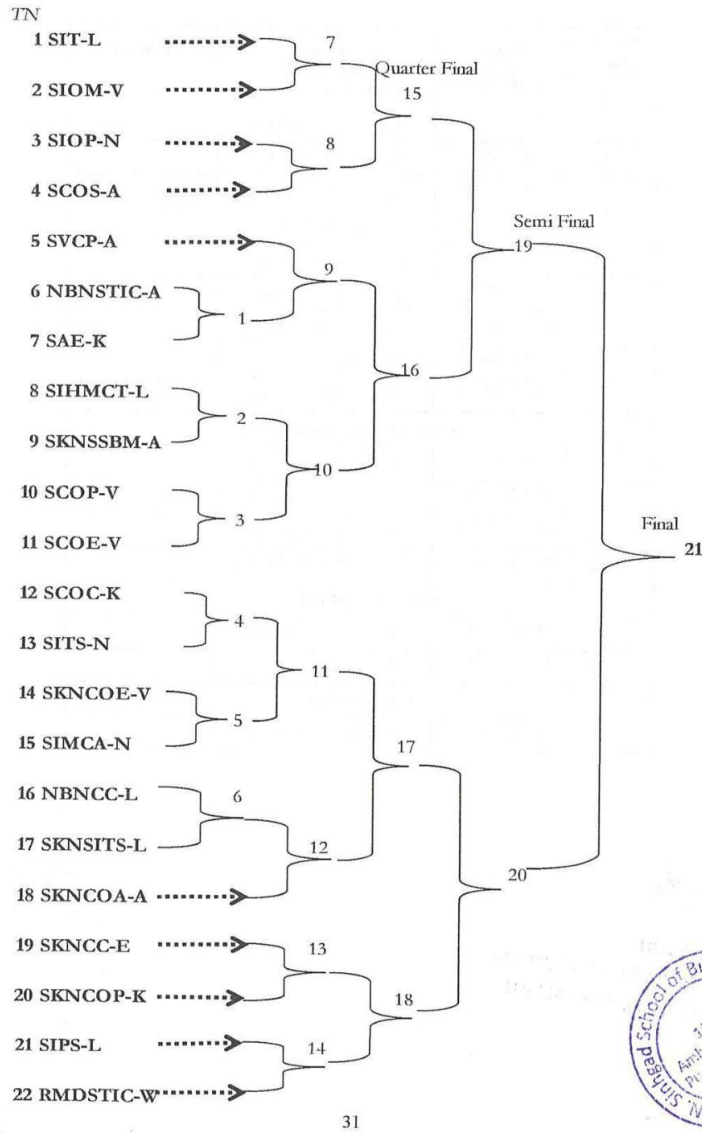

Handwritten signature

Director

S.K.M. Sinhgad School of Business Management
 S. No. 10/1, Ambegaon (B), Pune - 411 001



Sinhgad Technical Education Society's

SINHGAD SPORTS KARANDAK 2020



Match to match schedule for Table Tennis (Grils)

Match No.	Date	Time	Winner
1.	13/01/2020	10.00 am to 10.30 am	
2.	13/01/2020	10.30 am to 11.00 am	
3.	13/01/2020	11.00 am to 11.30 am	
4.	13/01/2020	11.30 am to 12.00 pm	
5.	13/01/2020	12.00 pm to 12.30 pm	
6.	13/01/2020	12.30 pm to 1.00 pm	
7.	13/01/2020	1.30 pm to 2.00 pm	
8.	13/01/2020	2.00 pm to 2.30 pm	
9.	13/01/2020	2.30 pm to 3.00 pm	
10.	13/01/2020	3.00 pm to 3.30 pm	
Quarter Final Matches			
11.	14/01/2020	10.30 am to 11.00 am	
12.	14/01/2020	11.00 am to 11.30 am	
13.	14/01/2020	11.30 am to 12.00 pm	
14.	14/01/2020	12.00 pm to 12.30 pm	
Semi Final Matches			
15.	14/01/2020	1.30 pm to 2.00 pm	
16.	14/01/2020	2.00 pm to 2.30 pm	
Final Match			
17.	14/01/2020	3.00 pm to 3.30 pm	

Director
S.K.N. Sinhgad School of Business Management
S. No. 10/1, Ambegaon (BK), Pune - 411 041





Sinhgad Technical Education Society's
SINHGAD SPORTS KARANDAK 2020



Table Tennis (Girls)

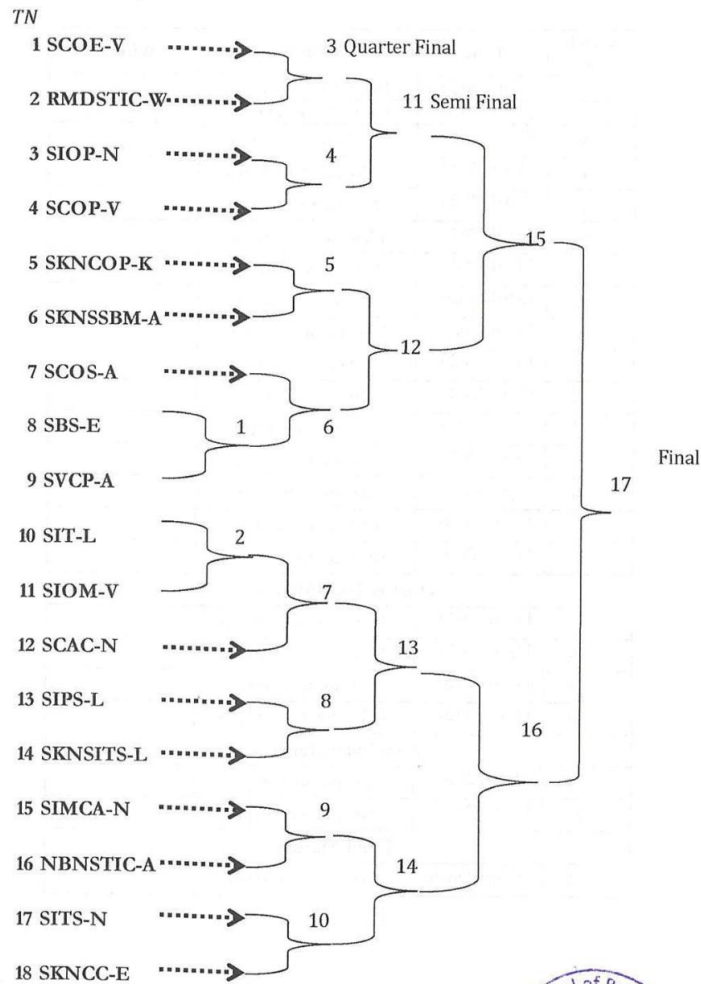

Handwritten signature

29



Director
S.K.N. Sinhgad School of Business Management
s. No. 10/1, Ambegaon (BK), Pune - 411 041



Sinhgad Technical Education Society's

SINHGAD SPORTS KARANDAK 2020



Match to match schedule for Table Tennis (Boys)

Match No.	Date	Time	Winner
1.	13/01/2020	10.00 am to 10.30 am	
2.	13/01/2020	10.30 am to 11.00 am	
3.	13/01/2020	11.00 am to 11.30 am	
4.	13/01/2020	11.30 am to 12.00 pm	
5.	13/01/2020	12.00 pm to 12.30 pm	
6.	13/01/2020	12.30 pm to 1.00 pm	
7.	13/01/2020	1.30 pm to 2.00 pm	
8.	13/01/2020	2.00 pm to 2.30 pm	
9.	13/01/2020	2.30 pm to 3.00 pm	
10.	13/01/2020	3.00 pm to 3.30 pm	
11.	13/01/2020	3.30 pm to 4.00 pm	
12.	13/01/2020	4.00 pm to 4.30 pm	
13.	13/01/2020	4.30 pm to 5.00 pm	
14.	14/01/2020	9.00 am to 9.30 am	
15.	14/01/2020	9.30 am to 10.00 pm	
16.	14/01/2020	10.00 am to 10.30 am	
Quarter Final Matches			
17.	14/01/2020	10.30 am to 11.00 am	
18.	14/01/2020	11.00 am to 11.30 am	
19.	14/01/2020	11.30 am to 12.00 pm	
20.	14/01/2020	12.00 pm to 12.30 pm	
Semi Final Matches			
21.	14/01/2020	1.30 pm to 2.00 pm	
22.	14/01/2020	2.00 pm to 2.30 pm	
Final Match			
23.	14/01/2020	3.00 pm to 3.30 pm	

Director

S.K.N. Sinhgad School of Business Management
S. No. 10/1, Ambegaon (P.K), Pune - 411 041

28





Sinhgad Technical Education Society's

SINHGAD SPORTS KARANDAK 2020



Table Tennis (Boys)

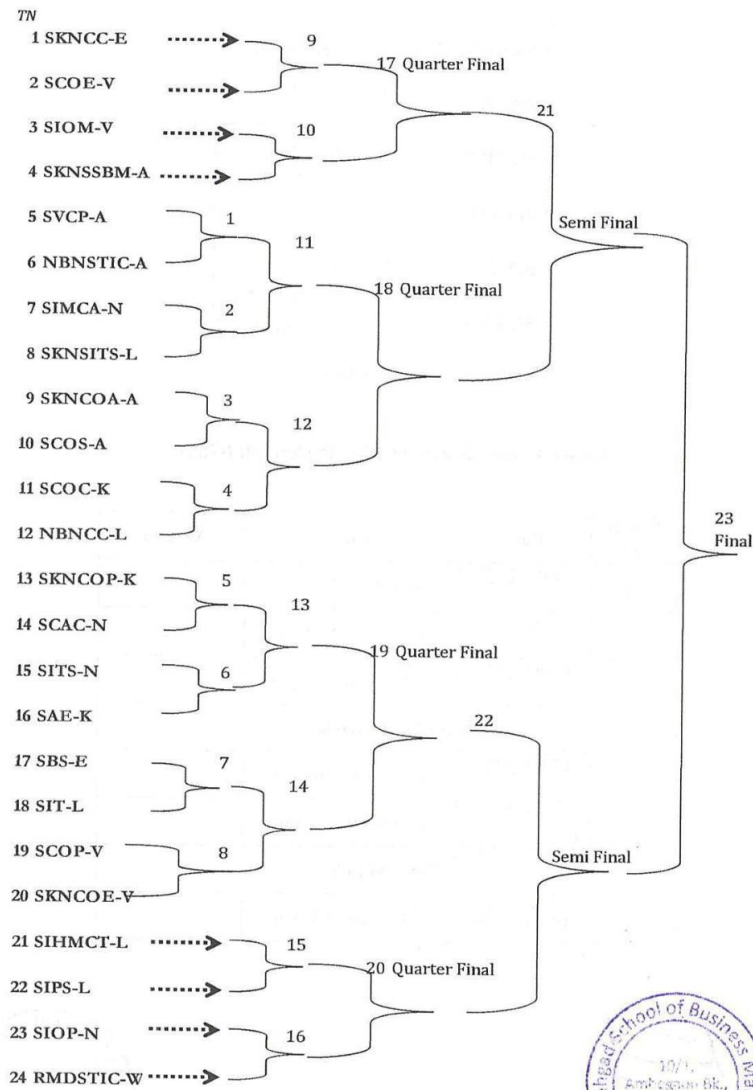

27

[Signature]
Director

S.K.N. Sinhgad School of Business Management
S. No. 10/1, Ambegaon (BK), Pune - 411 041





Sinhgad Technical Education Society's

SINHGAD SPORTS KARANDAK 2020



Basketball (Girls)

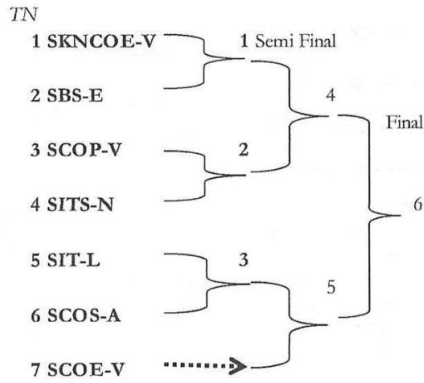

Match to match schedule for Basketball (Girls)

Match No.	Date	Time	Winner
1.	14/01/2020	10.00 am to 11.00 am	
2.	14/01/2020	11.00 am to 12.00 am	
3.	14/01/2020	12.00 pm to 1.00 pm	
Semi Final Matches			
4.	14/01/2020	1.00 pm to 2.00 pm	
5.	14/01/2020	2.00 pm to 3.00 pm	
Final Match			
6.	14/01/2020	3.30 pm to 4.30 pm	

Director

S.K.N. Sinhgad School of Business Management
 E. No. 10/1, Ambegaon (DK), Pune - 412 041

26





Sinhgad Technical Education Society's

SINHGAD SPORTS KARANDAK 2020



Basketball (Boys)

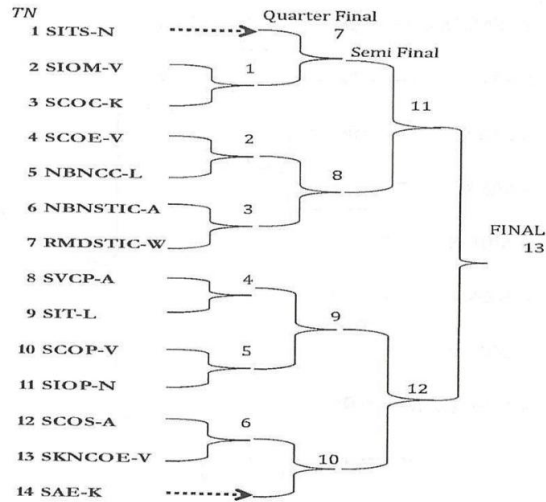

Match to match schedule for Basketball (Boys)

Match No.	Date	Time	Winner
First Round			
1.	15/01/2020	10.00 am to 11.00 am	
2.	15/01/2020	11.00 am to 12.00 pm	
3.	15/01/2020	12.00 am to 1.00 pm	
4.	15/01/2020	1.00 pm to 2.00 pm	
5.	15/01/2020	2.00 pm to 3.00 pm	
6.	15/01/2020	3.00 pm to 4.00 pm	
Quarter Final Matches			
7.	16/01/2020	10.00 am to 11.00 am	
8.	16/01/2020	11.00 am to 12.00 pm	
9.	16/01/2020	1.00 pm to 2.00 pm	
10.	16/01/2020	2.00 pm to 3.00 pm	
Semi Final Matches			
11.	17/01/2020	10.00 am to 11.00 am	
12.	17/01/2020	11.00 am to 12.00 pm	
Final Match			
13.	17/01/2020	1.00 pm to 2.00 pm	

Director

S.K.N. Sinhgad School of Business Management
S. No. 10/1, Ambegaon (BK), Pune - 411 041





Sinhgad Technical Education Society's

SINHGAD SPORTS KARANDAK 2020



Volley ball (Girls)

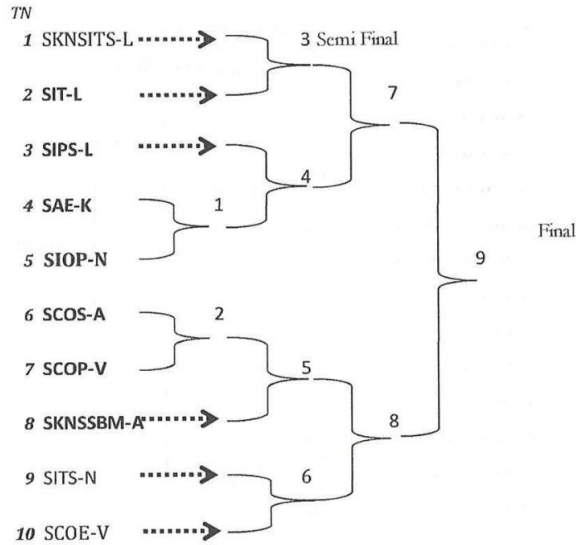

Match to match schedule for Volleyball (Girls)

Match No.	Date	Time	Winner
First Round			
1.	17/01/2020	9.00 am to 10.00 am	
2.	17/01/2020	10.00 am to 11.00 am	
3.	17/01/2020	11.00 am to 12.00 pm	
4.	17/01/2020	12.00 pm to 1.00 pm	
5.	17/01/2020	1.00 pm to 2.00 pm	
6.	17/01/2020	3.00 pm to 4.00 pm	
Semi Final Matches			
7.	20/01/2020	10.00 am to 11.00 am	
8.	20/01/2020	11.00 am to 12.00 pm	
Final Match			
9.	20/01/2020	1.00 pm to 2.00 pm	

Director

S.K.M. Sinhgad School of Business Management
S. No. 10/1, Ambegaon (Bk), Pune - 411 041

24





Sinhgad Technical Education Society's

SINHGAD SPORTS KARANDAK 2020



Match to match schedule for Volleyball (Boys)

Match No.	Date	Time	Winner
First Round			
1.	13/01/2020	10.00 am to 11.00 am	
2.	13/01/2020	11.00 am to 12.00 pm	
3.	13/01/2020	12.00 pm to 1.00 pm	
4.	13/01/2020	1.00 pm to 2.00 pm	
5.	13/01/2020	2.00 pm to 3.00 pm	
6.	13/01/2020	3.00 pm to 4.00 pm	
7.	14/01/2020	10.00 am to 11.00 am	
8.	14/01/2020	11.00 am to 12.00 pm	
9.	14/01/2020	12.00 pm to 1.00 pm	
10.	14/01/2020	1.00 pm to 2.00 pm	
11.	14/01/2020	2.00 pm to 3.00 pm	
12.	14/01/2020	3.00 pm to 4.00 pm	
Quarter Final Matches			
13.	15/01/2020	10.00 am to 11.00 am	
14.	15/01/2020	11.00 pm to 12.00 pm	
15.	15/01/2020	1.00 pm to 2.00 pm	
16.	15/01/2020	2.00 pm to 3.00 pm	
Semi Final Matches			
17.	16/01/2020	10.00 am to 11.00 am	
18.	16/01/2020	11.00 am to 12.00 pm	
Final Match			
19.	16/01/2020	2.00 pm to 3.00 pm	

Director

S.K.N. Sinhgad School of Business Management
S. No. 10/1, Ambegaon (BK), Pune - 411 041





Sinhgad Technical Education Society's

SINHGAD SPORTS KARANDAK 2020



Volley Ball (Boys)

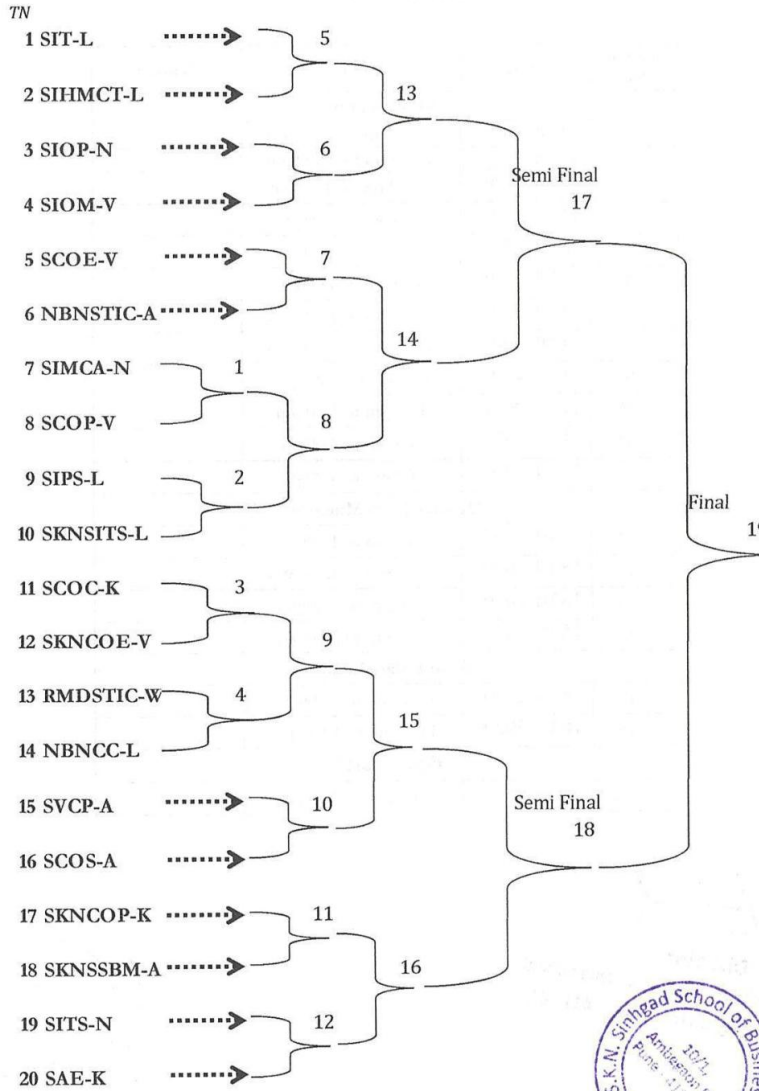

22



Director
 S.K.N. Sinhgad School of Business Management
 S. No. 10/1, Amhegaon (SI), Pune - 411 001



Sinhgad Technical Education Society's
SINHGAD SPORTS KARANDAK 2020



Football (Girls)

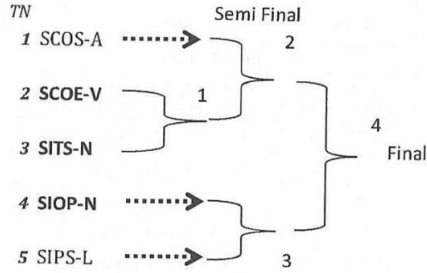

Match to match schedule for Football (Girls)

Match No.	Date	Time	Winner
1.	21/01/2020	11.00 am to 12.00 pm	
2.	21/01/2020	1.00 pm to 2.00 pm	
3.	21/01/2020	12.00 pm to 1.00 pm	
Final Match			
4.	21/01/2020	3.00 pm to 4.00 pm	

Director

S.K.N. Sinhgad School of Business Management
 S. No. 10/1, Ambegaon (BK), Pune - 411 041





Sinhgad Technical Education Society's

SINHGAD SPORTS KARANDA 2020



Match to match schedule for Football (Boys)

Match No.	Date	Time	Winner
First Round			
1.	17/01/2020	10.00 am to 11.00 am	
2.	17/01/2020	10.00 am to 11.00 am	
3.	17/01/2020	11.00 am to 12.00 pm	
4.	17/01/2020	11.00 am to 12.00 pm	
5.	17/01/2020	12.00 pm to 1.00 pm	
6.	17/01/2020	12.00 pm to 1.00 pm	
7.	17/01/2020	2.00 pm to 3.00 pm	
8.	17/01/2020	2.00 pm to 3.00 pm	
9.	17/01/2020	3.00 pm to 4.00 pm	
10.	17/01/2020	3.00 pm to 4.00 pm	
11.	18/01/2020	10.00 am to 11.00 am	
12.	18/01/2020	10.00 am to 11.00 am	
13.	18/01/2020	11.00 am to 12.00 pm	
14.	18/01/2020	11.00 am to 12.00 pm	
15.	18/01/2020	12.00 pm to 1.00 pm	
16.	18/01/2020	12.00 pm to 1.00 pm	
Quarter Final Matches			
17.	18/01/2020	2.00 pm to 3.00 pm	
18.	18/01/2020	2.00 pm to 3.00 pm	
19.	18/01/2020	3.00 pm to 4.00 pm	
20.	18/01/2020	3.00 pm to 4.00 pm	
Semi Final Matches			
21.	19/01/2020	10.00 am to 11.00 am	
22.	19/01/2020	10.00 am to 11.00 am	
Final Match			
23.	19/01/2020	12.00 pm to 1.00 pm	

Director

S.K.N. Sinhgad School of Business Management
S. No. 10/1, Ambegaon (BK), Pune - 411 041

20





Sinhgad Technical Education Society's
SINHGAD SPORTS KARANDAK 2020



Football (Boys)

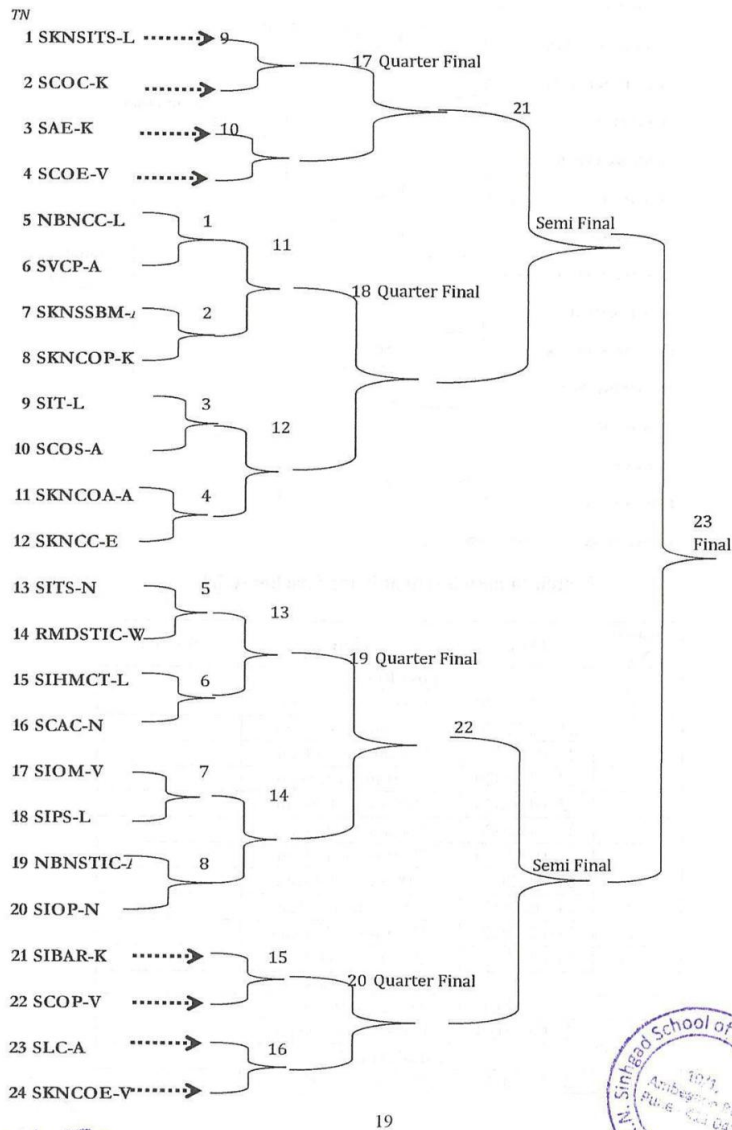

[Signature]
 Director

S.K.N. Sinhgad School of Business Management
 S. No. 10/1, Ambegaon (W), Pune - 411 041



SINHGAD SPORTS KARANDAK 2020



Cricket (Girls)

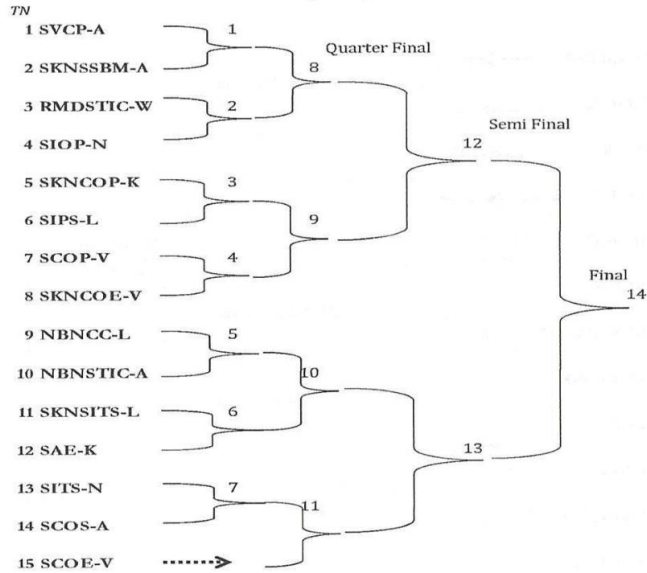

Match to match schedule for Cricket (Girls)

Match No.	Date	Time	Winner
First Round			
1.	21/01/2020	11.00 am to 1.00 pm	
2.	21/01/2020	2.00 pm to 4.00 pm	
3.	22/01/2020	9.00 am to 11.00 am	
4.	22/01/2020	11.00 am to 1.00 pm	
5.	22/01/2020	2.00 am to 4.00 pm	
6.	23/01/2020	9.00 am to 11.00 am	
7.	23/01/2020	11.00 am to 1.00 pm	
8.	23/01/2020	2.00 am to 4.00 pm	
9.	24/01/2020	9.00 am to 11.00 am	
10.	24/01/2020	11.00 am to 1.00 pm	
11.	24/01/2020	2.00 am to 4.00 pm	
Semi Final Matches			
12.	27/01/2020	9.00 am to 11.00 am	
13.	27/01/2020	11.00 pm to 1.00 pm	
Final Match			
14.	27/01/2020	2.00 pm to 4.00 pm	

18



Director

S.K.N. Sinhgad School of Business Management
S. No. 10/1, Ambegaon (BK), Pune - 411 041





Sinhgad Technical Education Society's

SINHGAD SPORTS KARANDAK 2020



Match to match schedule for Cricket (Boys)

Match No.	Date	Time	Winner
First Round			
1.	13/01/2020	11.00 am to 1.00 pm	
2.	13/01/2020	2.00 pm to 4.00 pm	
3.	14/01/2020	9.00 am to 11.00 am	
4.	14/01/2020	11.00 am to 1.00 pm	
5.	14/01/2020	2.00 pm to 4.00 pm	
6.	15/01/2020	9.00 am to 11.00 am	
7.	15/01/2020	11.00 am to 1.00 pm	
8.	15/01/2020	2.00 pm to 4.00 pm	
9.	16/01/2020	9.00 am to 11.00 am	
10.	16/01/2020	11.00 am to 1.00 pm	
11.	16/01/2020	2.00 pm to 4.00 pm	
12.	17/01/2020	9.00 am to 11.00 am	
13.	17/01/2020	11.00 pm to 1.00 pm	
14.	17/01/2020	2.00 am to 4.00 am	
15.	20/01/2020	9.00 am to 11.00 am	
16.	20/01/2020	11.00 am to 1.00 pm	
17.	20/01/2020	2.00 pm to 4.00 pm	
18.	21/01/2020	9.00 am to 11.00 am	
19.	21/01/2020	11.00 am to 1.00 pm	
Quarter Final Matches			
20.	21/01/2020	2.00 pm to 4.00 pm	
21.	22/01/2020	9.00 am to 11.00 am	
22.	22/01/2020	11.00 am to 1.00 pm	
23.	22/01/2020	2.00 pm to 4.00 pm	
Semi Final Matches			
24.	23/01/2020	9.00 am to 12.00 pm	
25.	23/01/2020	1.00 pm to 4.00 pm	
Final Match			
26.	24/01/2020	10.00 am to 1.30 pm	

Director

S.K.N. Sinhgad School of Business Management
S. No. 10/1, Ambegaon (BK), Pune - 411 041

17





Sinhgad Technical Education Society's



SINHGAD SPORTS KARANDAK 2020

Cricket (Boys)

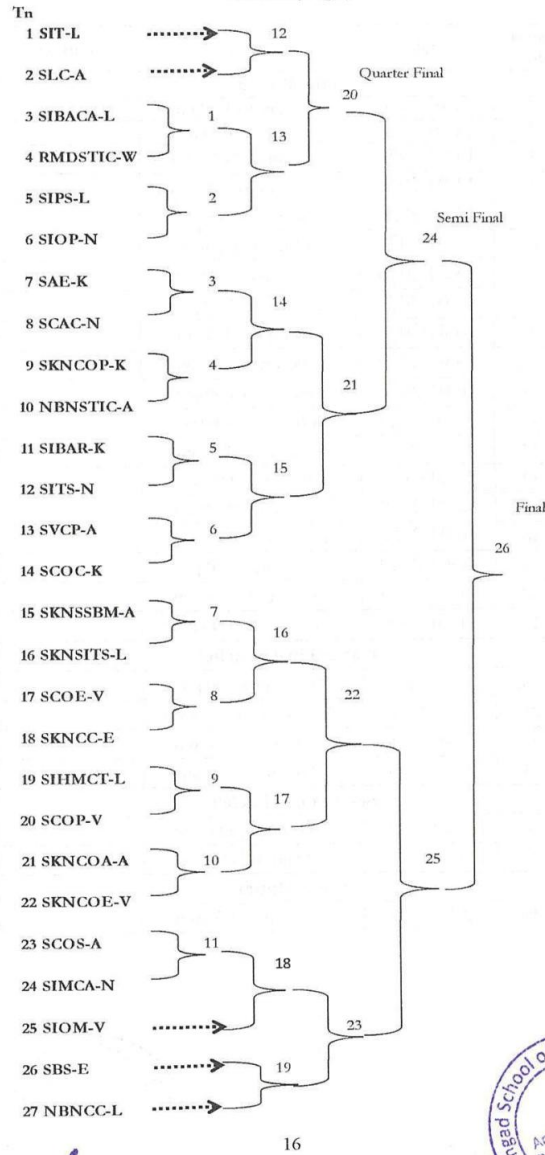

K. K. K.
Director

S.K.M. Sinhgad School of Business Management
S. No. 10/1, Ambegaon (BK), Pune - 411 041





Sinhgad Technical Education Society's



Sinhgad Sports Karandak 2020

3. The side winning a rally shall add a point to its score. A side shall win a rally, if the opposing side commits a "fault" or the shuttle ceases to be in play because it touches the surface of the court inside the opponent's court.
4. If the score becomes 15-all. (first and second set) or 21-all. (Third set), the side which gains a two-point lead first, shall win that game.
5. If the score becomes 19-all, the side scoring the 20th point shall win that game. (first and second set)
6. If the score becomes 29-all, the side scoring the 30th point shall win that game. (Third set)
7. The side winning a set shall serve first in the next set.

C. SERVICE

In a correct service:

1. Neither side shall cause undue delay to the delivery of the service once the server and the receiver are ready for the service;
2. On completion of the backward movement of the server's racket head, any delay in the start of the service, shall be considered to be an undue delay;
3. The whole shuttle shall be below the server's waist at the instant of being hit by the server's racket. The waist shall be considered to be an imaginary line round the body, level with the lowest part of the server's bottom rib;
4. Once started, the service is delivered when the shuttle is hit by the server's racket or, in attempting to serve, the server misses the shuttle.
5. The server shall not serve before the receiver is ready. However, the receiver shall be considered to have been ready if a return of the service is attempted.

D. SINGLES

1. The players shall serve from, and receive in, their respective right service courts when the server has not scored or has scored an even number of points in that game.
2. The players shall serve from, and receive in, their respective left service courts when the server has scored an odd number of points in that game.
3. If the server wins a rally, the server shall score a point. The server shall then serve again from the alternate service court.
4. If the receiver wins a rally, the receiver shall score a point. The receiver shall then become the new server.

Other rules such as service court errors, change of ends, faults, lets, shuttle not in play, continuous play, misconduct & penalties, officials and appeals will be applicable as the Badminton World Federation (BWF).

Director

S.K.N. Sinhgad School of Business Management
S. No. 10/1, Ambegaon (BK), Pune - 411 041

15





Sinhgad Technical Education Society's



Sinhgad Sports Karandak 2020

5. The time of the event has to be measured with a permitted automatic timing device.
6. The winner will be decided on the basis of minimum time among final round players.

Rules and Regulations for Relay (Boys and Girls)

1. 4 × 100 meters relay is a team event.
2. If the number of competitor is more than ten in the 100 meter running event, the heat round will be taken (winners or the top athlete will qualify for the next round) & then final.
3. The 4 × 100 meters is a running relay, where team is of four runners complete a race 100 meters each.
4. Among the four runners, the two runners will be at one end & other two runners on opposite side.
5. The baton for tagging must be passed within four players at every 100 meters
6. Any athlete with a false start will be disqualified.
7. The athlete will not be not given any credit if he or she does not finish the race.
8. The time of the event has to be measured with a permitted automatic timing device.
9. The winner will be decided on the basis of minimum time among final round teams.

Rules and Regulations for Badminton – Singles (Boys and Girls)

General Rules:

1. The Badminton event is treated as Individual (Singles) event.
2. For Boys (Single) and for girls (Single) can participate from each college.

A. TOSS

1. Before play commences, a toss shall be conducted and the side winning the toss shall exercise the choice in either to serve or receive first. The side losing the toss shall then exercise the remaining choice.

B. SCORING SYSTEM

1. A match shall consist of the best of three games First and Second set will be played with 15 points and third set will be played with 21 points [15-15-21]
2. A game shall be won by the side which first scores 15 points for first and second set and 21 points for third set.

Director
S.K.N. Sinhgad School of Business Management
S. No. 10/1, Ambegaon (BK), Pune - 411 041

14





Sinhgad Technical Education Society's



Sinhgad Sports Karandak 2020

7. Each time out basis a time limit of 30sec.
8. Bonus and cross will be considered as 01 point.
9. Every team should have proper kit for playing kabaddi.
10. All players are expected to know basic rules for kabaddi.

Rules and Regulations for Swimming (Boys and Girls)

1. All rules of the competition are followed by federation of International & National Amateur Association.
2. Swimming is treated as an individual event.
3. The event will be played as per ranking / timing.
4. The swimmer should maintain the lane discipline. If fouls, the participant will be disqualified.
5. Swimmer should wear a proper uniform/ costume.

In Freestyle 50-meter competition

1. In Freestyle event the swimmer will swim in only free style, the other style like backstroke, breaststroke or butterfly is not permitted, if found will be disqualified.
2. If the number of competitor is more than ten in the 50-meter freestyle event. The heat round will be taken (winners or the top athlete will qualify for the next round) & then final.
3. Some part of the swimmer must touch the wall upon completion of each length and at the finish.
4. If swimmer does not touch the wall while returning he will be disqualified.

Rules and Regulations for Running (Boys and Girls)

1. All rules & regulations are according to the Indian Amateur Athletic Association.
2. The athlete should maintain the lane discipline.
3. Athlete should be in proper uniform.

In 100 mt. running competition

1. 100 mt. running is a solo event.
2. If the number of competitor is more than ten in the 100 meter running event. The heat round will be taken (winners or the top athlete will qualify for the next round) & then final.
3. Any athlete with a false start will be disqualified.
4. The athlete is not given any credit if he or she does not finish the race.

Director

13



S.K.N. Sinhgad School of Business Management
S. No. 10/1, Ambegaon (BK), Pune - 411 041



Sinhgad Sports Karandak 2020

Rules and Regulations for Chess (Boys and Girls)

1. Chess is treated as a solo event
2. One boy & One Girl can participate from each college.
3. **Touch-move rule-**
 - If player touches one of his or her piece while having the move, then he or she must move it.
 - If a player touches one of the opponent's piece, then he or she must capture the piece if it can be captured.
4. Castling rule-castling is only permissible if all of the following conditions hold.
 - The king and rook involved in castling must not have previously moved.
 - There must be no pieces between the king and the rook.
 - The king should not currently in check nor should the king pass through or end up in square that is under attack by enemy's piece.
5. Draw- the game ends in draw if any of these conditions occur.
 - The game is automatically drawn if the player to move in checks but has no legal move. This situation is called stalemate.
 - Fifty moves have played by each player without any capture or a pawn being moved. (Fifty moves rule)
 - The same board position has occurred three times with the same player to move. (three-fold repetition rule)
 - No possible sequences of legal move lead to checkmate. Usually this is because there is insufficient material.
6. If the time limit ends, then winner will be decided as per points of remaining pieces on the chess board.
7. The time period of each match is 30 min.

Rules and Regulations for Kabaddi (Boys and Girls)

1. Each team should have 12 players of which 7 players on field and 05 are reserved accompanied by one team manager.
2. Only the players recorded on the score sheet may participate in the match.
3. Match time for boys 15 -5-15 mins. (35 mins) and for girls 10-5-10 mins. (25 mins)
4. Ground measurements for boys 13x10mtrs. and for girls 12x8 mtrs.
5. No weight bar.
6. Maximum two time outs are permitted in one half each team.

Director

12



S.K.N. Sinhgad School of Business Management
S. No. 10/1, Ambegaon (BK), Pune - 411 042



Rules and Regulations for Lawn Tennis (Boys and Girls)

1. The lawn tennis event is treated as solo event.
2. One boy & One Girl can participate from each college.
3. There are 4 Points in each game. Points 15, 30, 40 & game point.
 - If points are 40 – 40 then, it is said as dues.
 - Then there should be difference of 2 points.

Rules and Regulations for Lawn Tennis (Doubles)

The rules for doubles are the same as singles, except the wider court is used.

1. Players within a pair do not have to hit alternate shots.
2. However, the serve rotates so that each player serves once every fourth game.
3. For instance, from Player A in Pair A, to Player B in pair B, back to Player C in Pair A and then to Player D in Pair B.
4. Players can only change the order of serving and receiving at the end of a set.
5. The server's partner and the receiver's partner may stand anywhere they like on the court during the serve, even if it obstructs play.
6. Traditionally however, each player takes one side of the court.
7. At deuce the Receiving Team shall choose whether it wishes to receive the Service from the right half of the court or the left half of the court.
8. The team who wins the deciding point is scored the game.
9. **BALL FALLS ON LINE:** A ball falling on a line is regarded as falling in the Court bounded by that line.

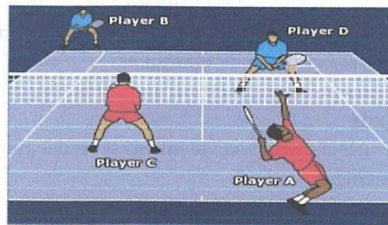

Director

S.K.N. Sinhgad School of Business Management
S. No. 10/1, Ambegaon (BK), Pune - 411 041

11





Rules and Regulations for Table Tennis Doubles & Mixed doubles

1. Two boys and Two Girls can participate from each college for Doubles (Boys/Girls).
2. One boy and One Girl can participate from each college for Mixed Double (Boys/Girls).
3. Each match is played with 11 points.

Service

Unlike the singles game where the ball can bounce anywhere on the table during service, in doubles, the ball can only bounce on the right half portion of the table for both the server and the receiver.

Like the singles game, the service still alternates every two points between teams, but it also alternates between players on the same team.

Once your team has finished your two serves, you swap sides with your partner. The person you were serving to now serve and your partner is the new receiver.

Order of Play

Doubles matches have a certain order of play that must be followed.

- Imagine two teams ... players A & B and players X & Y.
- Player A serves to player X who then returns the ball. Player B must then play the next shot and player Y the shot after.
- This pattern goes on (A, X, B, Y) until the point is decided.
- If the wrong player makes the return, the team loses the point.

Change of Service

At each change of service, the last receiver shall become the server and the partner of the previous server shall become the receiver. For example, a correct pattern would be:

- Player A has played his two serves to player X
- Player X then plays his two serves to player B.
- Player B will then play his two serves to Player Y
- player Y will play his two serves to Player A.

Player A will then restart the sequence all over again and the sequence will repeat itself until a changeover or the end of the game.

Change of Ends

A changeover occurs when one team has scored 5 points. This will also change up the order of receiving.

For instance, players A & B score 5 points first, whilst A is serving to X. After changing ends, player A will serve to player Y for the remainder of the game.

Director

S.K.N. Sinhgad School of Business Management
S. No. 10/1, Ambegaon (BK), Pune - 411 041





Sinhgad Technical Education Society's



Sinhgad Sports Karandak 2020

Rules and Regulations for Volleyball (Boys and Girls)

1. A team consists of a maximum 12 players accompanied by one team managers.
2. Only the players recorded on the score sheet must participate in the match.
3. The 6 players that begin a set compose the starting line-up.
4. Maximum two times out and 6 substitutions per team per set are permitted.
5. Each time out period will be of 30 seconds.
6. If a player is injured and cannot continue to play, he must be legally substituted.
7. Maximum 6 substitutions shall be allowed per team per set.
8. The team that first scores 25 points with a minimum advantage of two points is the Winner of a Set.
9. The team that wins 2 sets will be declared a winner.

Rules and Regulations for Basketball (Boys and Girls)

- 1) The game will be played in 4 quarters, each of 7 minutes. 1 minute break will be given after 1st and 3rd quarters and 3 minutes break after 2nd quarter.
- 3) If the score is equal at the end of the match, extra 3 minutes will be given.
- 4) One time-out is allowed in each quarter.
- 5) Fouls: Pushing, Blocking and Holding are not allowed.
- 6) Each team must have 12 players of which 3 shall be substitutes.

Rules and Regulations for Table Tennis-singles (Boys and Girls)

- 1 The table tennis singles event is treated as solo event.
- 2 One boy and One Girl can participate from each college.
- 3 Each match is played with 11 points (Difference of two points).

Director

S.K.N. Sinhgad School of Business Management
S. No. 10/1, Ambegaon (BK), Pune - 411 041





Sinhgad Technical Education Society's



Sinhgad Sports Karandak 2020

- 8 For each wide ball and no ball; ball will be counted and 2 runs will be awarded to batting side.
- 9 Last over of each inning, wide ball and no ball will not be counted and 2 runs will be awarded to batting side.
- 10 All players are expected to know basic rules for cricket.
- 11 In case of tie of match, winner will be declared based on wickets fall. If it is tie again, super over will be played.

Rules and Regulations for Football (Boys and Girls)

- 1) Timing – for Boys → 20 minutes each half with 5 minutes break 20-5-20(45 mins)
For Girls → 15 minutes each half with 5 minutes break 15-5-15(35 mins)
- 2) Number of players – 16 members team of which 11 playing inside the field and 5 players substitute.
- 3) Three players will be allowed for substitution.
- 4) Dress code – every team should have proper kit to play football so as to reduce injuries
1. Jersey, 2. Stocking 3. Shin guard.
- 5) Fouls in game –
 - a. If a player touches the ball with his hand, a kick will be given to the opponent.
 - b. When a player tackles his opponent roughly, a free kick will be given to the opponent.
 - c. If the false tackling is done in the penalty area, the opponent will be allotted a penalty.
 - d. If, other than goal keeper, the ball touches to any players in penalty area, hand penalty will be allotted to opponent.
 - e. Throw in – If the ball is kicked out of side line by one team, the other team will be allotted the throwing.
 - f. Corner kick – If the ball is kick out of goal line by the team, the opponents will be allotted the corner kick.
 - g. If the goals scored by both the teams are equal after the completion of the allotted time, , penalty shootout will be allotted 5 kicks to both the teams. The highest score team is the winner. If the score is equal again, each team will be given one-one chance, until the result comes.

Director

S.K.N. Sinhgad School of Business Management
S. No. 10/1, Ambegaon (BK), Pune - 411 041

8





Sinhgad Technical Education Society's



Sinhgad Sports Karandak 2020

Rules and Regulations for Cricket (Boys)

- 1 Each team should have 16 players.
- 2 All the matches will be played on Knock-out basis and of 12 overs each side.
- 3 The matches will be played using leather ball. Each bowler can bowl max 03 overs in 12 overs match.
- 4 Field restriction / circle rule: First three overs of each inning will be a power play, where maximum 2 fielders can stand out of the circle.
- 5 Semifinals and final matches will be played in 20-20 overs format.
- 6 All the teams should be in proper uniform and shoes.
- 7 The participating students should bring their own cricket kit except leather ball.
- 8 For each wide ball and no ball, ball has to be counted in a over and 2 runs will be awarded to the batting side. But last over of each inning, wide ball and no ball will not be counted and 2 runs will be awarded to batting side.
- 9 Overstep no ball will be counted; 2 runs will be awarded and next ball will be a free hit [not for last ball of the over].
- 10 All players are expected to know basic rules for cricket.
- 11 In case of tie of match, winner will be declared based on wickets fall. If it is tie again, super over will be played.

Rules and Regulations for Cricket (Girls)

- 1 Each team should have 16 players.
- 2 All the matches will be played on Knock-out basis and of 8 overs each side.
- 3 The matches will be played using tennis ball (double layer). Each bowler can bowl for 02 overs in 8 overs match.
- 4 Semifinals and final matches will be played in 12-12 overs format.
- 5 All the teams should be in proper uniform and shoes.
- 6 No field restriction rule (circle rule)
- 7 The participating students should bring their own cricket kit except tennis ball.

Director

S.K.N. Sinhgad School of Business Management
S. No. 10/1, Ambegaon (BK), Pune - 411 041

7





Sinhgad Technical Education Society's



Sinhgad Sports Karandak 2020

Category: Inter Campus Matches

General Rules and Regulations

1. Each team must be accompanied by staff member as a "Team Manager".
2. All the matches will be played on knockout basis.
3. Each team has to play a match as per lots and needs to finish within stipulated time. Each Team along with the team manager must report to respective venues before half an hour the match schedule.
4. The participating players must be regular bonafide student of the college. Valid College identity cards (2019-20) are compulsory for all players.
5. All the teams / players must be in proper sports uniform.
6. Transport and Mess facility will not be provided by Central Organizing Committee.
7. No T.A and D.A will be provided from organizing college.
8. Organizing college will bear all the expenses for organizing the allotted sport event.
9. Respective teams should carry their own sports accessories /equipment (e.g. cricket kit / tennis rackets / TT bat etc.).
10. If your team does not report on stipulated time, your team will be disqualified.
11. All rights are reserved with Central Organizing Committee.
12. Overall General Championship point/s will be calculated as follows,
 - a. Winner team / college: 02 points
 - b. Runner-up team / college: 01 point
 - c. Man of the series / women of the series / Golden boot team / college: 01 point
13. Referees/Umpires decision will be final. If any dispute occurs between two teams, the final decision will be taken by umpires/ referees as per rules. Any argument with the referee shall lead to disqualification of the entire team.
14. If the players found indulge with vicious arguments during match, both the teams will be disqualified. Team managers will be held responsible for the same.

Director

S.K.N. Sinhgad School of Business Management
S.No. 10/1, Ambegaon (BK), Pune - 411 041

6





Sinhgad Technical Education Society's



Sinhgad Sports Karandak 2020

Table of various Responsibilities

Sr. No.	Responsibility	Institute
1	<ul style="list-style-type: none">Overall Co-ordination.Registration Forms. Distribution, Collection & Analysis.Rule Book Preparation & approval.Drawing of Lots.Submission of Final report.	NBNSTIC-A
2	<ul style="list-style-type: none">Overall Co-ordination.Approval for Requirements & Design of Trophies, Medals, Flex, Flyer, Certificates.Purchase orders & Procurement.Distribution & Maintaining Records.Submission of Daily report.	SCOS-A
3	<ul style="list-style-type: none">Overall coordination of activities in respective campusEnsuring readiness of grounds & other facilitiesEnsuring smooth conduction of events in the campus.Submission of Daily report	NBNSTIC-V SCOS-A SIMCA-N RMDSTIC-W SKNCOP-K SAE-K SKNSITS-L
4	Overall coordination of Bus Transport arrangements with toll payments for Vadgaon-Ambegaon Campus.	SKNCOE-V
5	Overall coordination of Bus Transport arrangements with toll payments for Warje Campus.	RMD STIC-W
6	Overall coordination of Bus Transport arrangements with toll payments for Kondhwa & Erandwane Campus.	SAE-K
7	Overall coordination of Bus Transport arrangements with toll payments for Narhe Campus.	SITS-N
8	Overall coordination of Bus Transport arrangements with toll payments for Lonavala Campus.	SKNSITS-L

Dr. (Mrs) Sunanda M. Navale
Founder Secretary, STES
Secretary, Sinhgad Sport Club & Cultural Centre

Mr. Rohit M. Navale
Vice. President (HR), STES
Chairman, Sinhgad Sport Club & Cultural Centre

Director
S.K.N. Sinhgad School of Business Management
S. No. 10/1, Ambegaon (BK), Pune - 411 041

4



Scanned by CamScanner



Sinhgad Technical Education Society's



Sinhgad Sports Karandak 2020

Sr. No	Sport Event	Proposed Dates From-to	Proposed Venue	Responsible Institutes
16	Lawn Tennis - Doubles (Boys)	15 Jan 2020	Lawn Tennis Court, Lonavala Campus	SIBACA-L & SBS-E
17	Lawn Tennis - Doubles (Girls)	14 Jan 2020	Lawn Tennis Court, Vadgaon Campus	SCOP-V & SVCP-A
18	Lawn Tennis - Mixed Double	16 Jan 2020	Lawn Tennis Court, Vadgaon Campus	SCOP-V & SVCP-A
19	Kabaddi (Boys)	13-14 Jan 2020	Kabaddi ground, Lonavala	SAE-K & SIHMCT-L
20	Kabaddi (Girls)	13 Jan 2020	RMD-STIC- Warje Campus	RMDSTIC-W & SIBAR-K
21	Chess (Boys)	13-14 Jan 2020	SKNCOA, Ambegaon Campus	SKNCOA-Ambegaon
22	Chess (Girls)	15 Jan 2020	SKNCOA, Ambegaon Campus	SKNSCOA-Ambegaon
23	Swimming (Boys)	13 Jan 2020	Swimming Pool, Lonavala Campus	SIHMCT- L & SKNCC-E
24	Swimming (Girls)	14 Jan 2020	Swimming Pool, Lonavala Campus	SIHMCT- L & SKNCC-E
25	Athletics - Running 100 m (Boys)	13 Jan 2020	Athletic tracks, Lonavala Campus	NBNCC-L & SIPS-L
26	Athletics - Running 100 m (Girls)	14 Jan 2020	Athletic tracks, Lonavala Campus	NBNCC-L & SIPS-L
27	Athletics - Relay (4x100m) (Boys)	13 Jan 2020	Athletic tracks, Lonavala Campus	NBNCC-L & SIPS-L
28	Athletics - Relay (4x100m) (Girls)	14 Jan 2020	Athletic tracks, Lonavala Campus	NBNCC-L & SIPS-L
29	Badminton(Boys)	20-22 Jan 2020	Indoor sports complex, Lonavala Campus	SIPS-L & SKNCOP-K
30	Badminton (Girls)	23-25 Jan 2020	Indoor sports complex, Lonavala Campus	SIPS-L & SKNCOP-K

Dr. (Mrs) Sunanda M. Navale
Founder Secretary, STES
Secretary, Sinhgad Sport Club & Cultural Centre

Mr. Rohit M. Navale
Vice. President (HR), STES
Chairman, Sinhgad Sport Club & Cultural Centre

S.K.N. Singh
Director
S.K.N. Sinhgad School of Business Management
S. No. 10/1, Ambegaon (BK), Pune - 411 041



Scanned by CamScanner



Sinhgad Technical Education Society's

Sinhgad Sports Karandak 2020



STES Inter-Campus Sports Events (13 Jan 2020 - 28 Jan 2020/ 16 Days)

Sr. No	Sport Event	Proposed Dates From-to	Proposed Venue	Responsible Institutes
1	Cricket (Boys)	13 - 24 Jan 2020	Cricket Ground, Lonavala Campus	SIT-L & SITS-N
2	Cricket (Girls)	21 - 28 Jan 2020	STES Cricket Ground, Vadgaon Campus	SCOE-V & SKNCOE-V
3	Football (Boys)	17 - 21 Jan 2020	STES Football Grounds Lonavala Campus	SKNSITS-L & SAE-K
4	Football (Girls)	21 Jan 2020	STES Football Ground-2 Lonavala Campus	SKNSITS-L & SAE-K
5	Volleyball (Boys)	13 - 16 Jan 2020	School Volleyball Court. RMD- STIC Warje	RMD-STIC- W & SLC-A
6	Volleyball (Girls)	17-20 Jan 2020	School Volleyball Court. RMD- STIC Warje	RMD-STIC- W & SKNSSBM-A
7	Basketball (Boys)	15 - 17 Jan 2020	Basketball Court. Lonavala Campus	SIBACA-L & SLC-A
8	Basketball (Girls)	14 Jan 2020	Basketball Court. Kondhwa Campus	SCOC-K
9	Table Tennis (Boys)	13-14 Jan 2020	SIMCA, Narhe (Top) Campus	SIMCA- N & SCAC-N
10	Table Tennis (Girls)	13-14 Jan 2020	SIOP, Narhe (Top) Campus	SIOP- Narhe
11	Table Tennis - Doubles (Boys)	15-16 Jan 2020	SIMCA, Narhe (Top) Campus	SIMCA- N & SCAC-N
12	Table Tennis - Doubles (Girls)	15 Jan 2020	SIOP, Narhe (Top) Campus	SIOP- Narhe
13	Table Tennis Mixed Doubles	17 Jan 2020	SIMCA, Narhe (Top) Campus	SIMCA- N & SCAC-N
14	Lawn Tennis (Boys)	13-14 Jan 2020	Lawn Tennis Court , Lonavala Campus	SIBACA-L & SBS-E
15	Lawn Tennis (Girls)	13 Jan 2020	Lawn Tennis Court, Vadgaon Campus	SCOP-V & SVCP-A

Dr. (Mrs) Sunanda M. Navale
 Founder Secretary, STES
 Secretary, Sinhgad Sport Club & Cultural Centre

Mr. Rohit M. Navale
 Vice. President (HR), STES
 Chairman, Sinhgad Sport Club & Cultural Centre

Cont...



Director

S.K.N. Sinhgad School of Business Management
 S. No. 10/1, Ambegaon (RS), Pune - 411 041



Scanned by CamScanner



Sinhgad Technical Education Society's



Sinhgad Sports Karandak 2020

Proposed Sports Events, Dates and Responsibilities

International Student Matches (07-14 Jan 2020/ 8 Days)

Sr. No.	Sport Event	Proposed Dates From-to	Proposed Venue	Responsible Institutes
1	Cricket (Boys)	07-09 Jan 2020	Cricket Ground, Lonavala Campus	SIT-L & SITS-N
2	Football (Boys)	10-11 Jan 2020	Football Grounds, Lonavala Campus	SKNSITS-L & SIOM-V
3	Football (Girls)	10-11 Jan 2020	Football Ground, Lonavala Campus	SKNSITS-L & SIOM-V
4	Volleyball (Boys)	13-14 Jan 2020	Volleyball Court, Lonavala Campus	SKNCOET-L & SKNSSBM - A
5	Basketball (Boys)	13-14 Jan 2020	Basketball Court, Lonavala Campus	NBNCC-L & SL-C-A

Inter-Collegiate (Invitational) Matches (08 Jan 2020-20 Jan 2020/ 13 Days)

Sr. No.	Sport Event	Proposed Dates From-to	Proposed Venue	Responsible Institutes
1	Cricket (Boys)	08-20 Jan 2020	STES Cricket Ground, Vadgaon Campus	SCOE-V & SKNCOE-V
2	Football (Boys)	13-16 Jan 2020	Football Grounds, Lonavala Campus	SKNSITS-L & SIOM-V
3	Volleyball (Boys)	08-10 Jan 2020	School Volleyball Court, RMD-STIC Warje	RMD-STIC- W & SCOC-K
4	Basketball (Boys)	08-13 Jan 2020	Basketball Court Kondhwa Campus	SIBAR-K & SKNCOP-K

Dr. (Mrs) Sunanda M. Navale
Founder Secretary, STES
Secretary Sinhgad Sport Club & Cultural Centre

Mr. Rohit M. Navale
Vice. President (HR), STES
Chairman, Sinhgad Sport Club & Cultural Centre

Director
S.K.N. Sinhgad School of Business Management
S. No. 10/1, Ambegaon (Pune) Pune - 411 041



Scanned by CamScanner



Sinhgad Technical Education Society's

SINHGAD SPORTS KARANDAK 2020



List of Participating Colleges (Campuses-wise)

Sr. No	Acronym (Short form)	Name of the College / Institutes	Sr. No	Acronym (Short form)	Name of the College / Institutes
I. Vadgaon Bk (V) Campus			IV. Lonavala (L) Campus		
1	SCOE-V	Sinhgad College of Engineering (V)	15	SIBACA- L	Sinhgad Institute of Business Administration & Computer Application (L)
2	SKNCOE-V	Smt. Kashibai Navale College of Engineering (V)	16	SIT-L	Sinhgad Institute of Technology (Engg+MBA+MCA) (L)
3	SCOP-V	Sinhgad College of Pharmacy (V)	17	SKNSITS-L	SKN Sinhgad Institute of Technology & Science (L)
4	SIOM- V	Sinhgad Institute of Management (V)	18	SIHMCT-L	Sinhgad Institute of Hotel Management & Catering Technology (L)
II. Ambegaon (A) Campus			19	NBNCC-L	Nivrutti Babaji Navale College of Commerce (Sr) (L)
5	NBN-STIC-A	NBN- Sinhgad Technical Institute Campus (A)	20	SIPS-L	Sinhgad Institute of Pharm. Science (L)
6	SKN-SSBM-A	Smt. Kashibai Navale Sinhgad School of Business Management (A)	21	SKNCOET (B.Ed)-L	Smt. Kashibai Navale College of Education & Training (B.Ed) (L)
7	SVCP-A	Sou. Venutai Chavan Polytechnic (A)	V. Narhe (N) Campus		
8	SLC-A	Sinhgad Law College (A)	22	SITS- N	Sinhgad Institute of Technology & Science (N)
9	SCOS -A	Sinhgad College of Science – (Jr+Sr) (A)	23	SIMCA-N	Sinhgad Institute of Management & Computer Application (N)
10	SKNCOA-A	Smt. Kashibai Navale College of Architecture (A)	24	SIOP-N	Sinhgad Institute of Pharmacy (N)
III. Kondhwa (K) Campus			25	SCAC(Jr+Sr)-N	Sinhgad College of Arts & Commerce (Jr+Sr) (N)
11	SAE-K	Sinhgad Academy of Engineering (K)	VI. Erandwane (E) Campus		
12	SIBAR-K	Sinhgad Institute of Business Administration & Research (K)	26	SKNCC-E	Smt. Kashibai Navale College of Commerce (E)
13	SKNCOP-K	Smt. Kashibai Navale College of Pharmacy (K)	27	SBS-E	Sinhgad Business School (E)
14	SCOC-K	Sinhgad College of Commerce (Jr+Sr) (K)	VII. Warje (W) Campus		
			28	RMD-STIC-W	RMD Sinhgad Technical Institutes Campus (W)
Total no. of Campuses = 07					
Total no. of STES Colleges participating = 28					

Dr. (Mrs.) Sunanda M. Navale
 Founder Secretary, STES
 Secretary, Sinhgad Sports Club & Cultural Centre

Mr. Rohit M. Navale
 Vice-president (HR), STES
 Chairman, Sinhgad Sports Club & Cultural Centre



S.K.N. Sinhgad School of Business Management
 S. No. 10/1, Ambegaon Bk., Pune - 411 041



Sinhgad Technical Education Society's



SINHGAD SPORTS KARANDAK 2020

INDEX

SN	Contents	Page No
1.	List of Participating STES Colleges	1
2.	Schedule and allotted responsibilities (International, Intercollegiate and Intercampus)	2-5
3.	Rules for all sports events	6-15
4.	Intercampus Lots and match to match schedule	16-50
5.	Contact details of sports coordinators	51-53

Director

S.K.N. Sinhgad School of Business Management
S. No. 10/1, Ambegaon (BK), Pune - 411 041





Sinhgad Institutes

SINHGAD SPORTS KARANDAK

2020



SPORTS RULES, LOTS & SCHEDULE

hik
Director

S.K.N. Sinhgad School of Business Management
S. No. 10/1, Ambegaon (BK), Pune - 411 041



Sinhgad Technical Education Society's
SKN Sinhgad School of Business Management, PUNE-41

Faculty Responsibility chart

Sr. No.	Sports Event	Faculty Coordinator
1	Cricket (Boys) Cricket (Girls)	Prof.Sanchit Pansare,Prof. Pravin Bodade
2	Football (Boys) Football (Girls)	Dr. Ganesh Yadav,Dr. Rahul Wagh
3	Volleyball (Boys) Volleyball (Girls)	Prof.Prapti Dhanshetty,Dr. Dattatray Rane
4	Table Tennis (Boys) Table Tennis (Girls)	Dr. Sangita Gorde
5	Table Tennis - Doubles (Boys) Table Tennis - Doubles (Girls)	Dr.Shalaka Sakharekar,Dr. Sadhana Ogale
6	Table Tennis – Mixed Doubles	Prof.Roza Parashar
7	Kabaddi (Boys) Kabaddi (Girls)	Prof. Mayuri Yadav
8	Chess (Boys) Chess (Girls)	Prof. Sheetal Sarnot
9	Athletics - Running 100 m (Boys) Athletics - Running 100 m (Girls)	Prof. Kalpana Sayankar, Prof. Sambhaji Pawar
10	Athletics - Relay (4x100m) (Boys) Athletics - Relay (4x100m) (Girls)	Prof. Ajeeta More,Prof. Manjula Dhulipala
11	Badminton (Boys) Badminton (Girls)	Prof. Lata Bajare,Prof. Rosy Kalia

Director
S.K.N. Sinhgad School of Business Management
S. No. 10/1, Ambegaon (BK), Pune - 411 041



Date: 26/12/2019

To,
The Director,
SKNSSBM, Ambegaon Pune

Sub: Participation in Sinhgad Sports Karandak 2020

Dear Madam,

You are requested to permit the students of MBA I & II of S.K.N.Sinhgad School of Business Management to participate in "Sinhgad Sports Karandak -2020" From 7th January to 31th January 2020.

Details of programme have been given herewith for your reference.

Bodade

Thanking You,

Prof. Pravin Bodade
Prof. Kalpana Sayankar
Prof. Sanchit Pansare

Kide

S.K.N. Sinhgad School of Business Management
S. No. 10/1, Ambegaon (BK), Pune - 411 041



Kondhwa Campus

Sr.No.	Name of College
1	Sinhgad Academy of Engineering (SAE), Kondhwa Campus
2	Sinhgad Institute of Business Administration and Research (SIBAR), Kondhwa Campus
3	Smt. Kashibai Navale College of Pharmacy (SKNCOP), Kondhwa
4	Sinhgad College of Arts, Science & Commerce (SCOS), Kondhwa Campus

Note: The colleges/institutes selected for the final round will be declared after the preliminary round based on respective event participation.

Lonavala Campus

Sr No	Name of College
1	Sinhgad Institute of Technology (SIT), Lonavala Campus
2	Sinhgad Institute of Business Administration & Computer Application (SIBACA) Lonavala Campus
3	Sinhgad Institute of Pharmaceutical Sciences (SIPS) Lonavala Campus
4	Smt. Kashibai Navale College of Education & Training (B.Ed) Lonavala Campus
5	Sinhgad Institute of Hotel Management and Catering Technology, Lonavala Campus
6	Nivrutti Babaji Navale College of Commerce, Lonavala Campus
7	SKN Sinhgad Institute of Technology & Science, (SKNSITS) Lonavala Campus.

Note: The colleges/institutes selected for the final round will be declared after the preliminary round based on respective event participation.

Sr No	Name of college
1	International Students

Director
S.K.N. Sinhgad School of Business Management
S. No. 10/1, Ambegaon (BK), Pune - 411 041



Scanned by CamScanner

Vadgaon –Ambegaon Campus

Sr No	Name of College
1	Sinhgad College of Engineering (SCOE), Vadgaon Bk. Campus
2	Smt. Kashibai Navale College of Engineering (SKNCOE), Vadgaon Bk. Campus
3	Sinhgad Institute of Management (SIOM), Vadgaon Bk. Campus
4	Sinhgad College of Pharmacy (SCOP), Vadgaon Bk. Campus
5	Sinhgad College of Architecture (SCOA), Vadgaon Bk. Campus
6	Sou. Venutai Chavan Polytechnic (SVCP), Ambegaon Bk. Campus
7	Smt. Kashibai Navale Sinhgad School of Business Management (SKNSSBM), Ambegaon Bk. Campus
8	Sinhgad College of Science (SCOS), Ambegaon Bk. Campus
9	Sinhgad Law College (SLC), Ambegaon Bk. Campus
10	NBN Sinhgad Technical Institutes Campus (NBNSTIC), Ambegaon Bk. Campus
11	Smt. Kashibai Navale College of Architecture, Ambegaon Campus

Note : The colleges/institutes selected for the final round will be declared after the preliminary round based on respective event participation.

Narhe Campus, Erandwane Campus and Warje Campus

(All events at Warje Campus)

Sr No	Name of College
1	Sinhgad Institute of Technology and Science (SITS), Narhe Campus
2	Sinhgad Institute of Management & Computer Application (SIMCA), Narhe Campus
3	Sinhgad Institute of Pharmacy (SIOP), Narhe Campus
4	Sinhgad College of Arts, Science & Commerce, Narhe Campus
5	RMD Sinhgad Technical Institutes Campus, Warje
6	Sinhgad Business School (SBS) Erandawane
7	Smt. Kashibai Navale College of Commerce (SKNCOC), Erandawane

Note: The colleges/institutes selected for the final round will be declared after the preliminary round based on respective event participation.



Director

S.K.N. Sinhgad School of Business Management
S. No. 10/1, Ambegaon (BK), Pune - 411 041



Scanned by CamScanner

SINHGAD KARANDAK-NEON 2020

TEAMS COMPETING AT NEON 2020

Sr. No.	Vadgaon + Ambegaon + Erandawane + Narhe + Warje+ Kondhwa + Lonawala
1	Sinhgad College of Engineering (SCOE), Vadgaon Bk. Campus
2	Smt. Kashibai Navale College of Engineering (SKNCOE), Vadgaon Bk. Campus
3	Sinhgad Institute of Management (SIOM), Vadgaon Bk. Campus
4	Sinhgad College of Pharmacy (SCOP), Vadgaon Bk. Campus
5	Sinhgad College of Architecture (SCOA), Vadgaon Bk. Campus
6	Sou. Venutai Chavan Polytechnic (SVCP), Ambegaon Bk. Campus
7	Smt. Kashibai Navale Sinhgad School of Business Management (SKNSSBM), Ambegaon Bk. Campus
8	Sinhgad College of Science (SCOS), Ambegaon Bk. Campus
9	Sinhgad Law College (SLC), Ambegaon Bk. Campus
10	NBN Sinhgad Technical Institutes Campus (NBNSTIC), Ambegaon Bk. Campus
11	Smt. Kashibai Navale College of Commerce (SKNCOC), Erandawane
12	Sinhgad Business School (SBS), Erandawane
13	Sinhgad Institute of Technology and Science (SITS), Narhe Campus
14	Sinhgad Institute of Management & Computer Application (SIMCA), Narhe Campus
15	Sinhgad Institute of Pharmacy (SIOP), Narhe Campus
16	Sinhgad College of Arts, Science & Commerce, Narhe Campus
17	RMD Sinhgad Technical Institutes Campus, Warje
18	Sinhgad Academy of Engineering (SAE), Kondhwa Campus
19	Sinhgad Institute of Business Administration and Research (SIBAR), Kondhwa Campus
20	Smt. Kashibai Navale College of Pharmacy (SKNCOP), Kondhwa
21	Sinhgad College of Arts, Science & Commerce (SCOS), Kondhwa Campus
22	Sinhgad Institute of Technology (SIT), Lonavala Campus
23	Sinhgad Institute of Business Administration & Computer Application (SIBACA) Lonaval Campus
24	Sinhgad Institute of Pharmaceutical Sciences (SIPS) Lonaval Campus
25	Smt. Kashibai Navale College of Education & Training (B.Ed/D.Ed) Lonavala Campus
26	Sinhgad Institute of Hotel Management and Catering Technology, Lonavala Campus
27	Nivrutti Babaji Navale College of Commerce, Lonaval Campus
28	SKN Sinhgad Institute of Technology & Science, (SKNSIT) Lonaval Campus.
29	International Students
30	Smt. Kashibai Navale College of Architecture, Ambegaon Bk. Campus

 Director
 S.K.N. Sinhgad School of Business Management
 S. No. 10/1, Ambegaon (BK), Pune - 411041



Scanned by CamScanner

13.	5 piece drum kit (with 1 crash & 1 ride), monitors along with sound system will be provided by the organizers. Other instruments and extra amplifiers (if needed) to be arranged by participants.
14.	Every team should consist of maximum 8 members with the valid college ID card. Team can consist of students from different colleges.
15.	Use of Obscene gestures and language (lyrics) is strictly prohibited.

Important Note:

- a) Cash prize and Entry fees are applicable to Intercollegiate competition.
- b) Online registration of entries on our website (www.sinhgadkarandak.org) will be from 24th January 2020 till 30th January 2020.
- c) All the respective coordinators or representative appointed by Principal/Directors should be present at the time of lots for deciding sequence for performances. Entries of Colleges/Institutes failing to attend the lots will be cancelled.
- d) Use of colors and fire are strictly not allowed.
- e) For all details at venue, you are requested to contact the concerned coordinator.
- f) One student can participate only in one event.
- g) Institute is not responsible for providing anything except stage and green room.
- h) Minimum requirement of musical instrument and light arrangement will be provided by the organizer.
- i) All the parking should be at the allocated parking area.
- j) Participants should carry along with them their valid college Identity card.
- k) Any Misbehavior on the part of the participants will result in disqualification.
- l) Institute will not be responsible for Students personal belongings.
- m) Using vehicles, animals, use of obscene clothing or any other instruments are not allowed.
- n) Decision of judges will be final and binding on all the participants.
- o) Right of admission will be reserved with the organizers.
- p) Organizers hold the right to amend any changes in the event without prior intimation.



Dr. (Mrs.) Sunanda M. Navale
 Founder Secretary, STES &
 Secretary, Sinhgad Cultural Centre

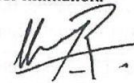

Mr. Rohit M. Navale
 Vice President (HR), STES &
 Chairman, Sinhgad Cultural Centre



Director
 S.K.N. Sinhgad School of Business Management
 S. No. 10/1, Ambegaon (BK), Pune - 411 041



6. Mr. & Ms. Sinhgad:(Personality Contest):	<ul style="list-style-type: none"> • One Team is permissible per college. The entries will be individual entries (One male & One female). • Duration: 03 Minutes per team of two. • The contest would comprise of 03 rounds. • 1st Round: Costume & Introduction -1 min. • 2nd Round: Talent Round – 1 min. • 3rd Round: Rapid fire Round – 1 min.
7. Fashion Show:	<ul style="list-style-type: none"> • One Team is permissible per college. • A team would consist of minimum 12 students and maximum 24 students (Min.06 Pairs & Max, 12 pairs). • Each team will be judged on the basis of Theme, Costume, and presentation. • Props ,accessories and set height not to exceed 9 feet • Duration: 9 minutes for final round per team including setup time.

8. Aegis of Rock	
1. Number of rounds: 2	1st round will be online and the final will be live performance. In the first round (online) each band will submit their maximum 01 Min 30 Sec (videos exceeding mentioned time will be disqualified) video song (Hindi/ English) in .avi or .wmv format to Sinhgad Institutes' Sinhgad College Of Engineering, (Vadgaon) Pune along with registration fees of Rs. 1500/- (Between 25 st December 2019 to 22 th January 2020). Maximum 30 bands will be selected on first come first serve basis during mentioned time period.
2.	No Metal Bands will be allowed.
3.	Videos of above mentioned 30 bands will be uploaded to our Facebook Page (25 th December 2019 to 22 th January 2020).
4.	Among all the bands, the top 12 who get the maximum likes during mentioned time period will be selected for the second round.
5.	Entry fee: The 12 selected bands will have to pay Rs.500/- before the performance in final round.
6.	In final round each Band will perform one cover & one Original Composition in a total time of 15 Min. including setup time & sound check.
7.	The cover song should be in Hindi only; the original composition can be in Hindi/English.
8.	The cover song should be a mashup of more than 2 Hindi songs (No regional language).
9.	Each band will be judged on the basis of stage presence, skills and originality.
10.	If any band exceeds the time slot or fails to follow rules given will be disqualified on the spot.
11.	The winning band will get cash prize of Rs 1,00,000/- and 1 st runner up will get cash prize of Rs. 50,000/- . The Top 3 bands will get an opportunity to perform on the final day of Sinhgad Karandak - Neon 2017.
12.	On the final day top three bands will perform for 30mins each including sound check and other setup time.

hike
Director

S.K.N. Sinhgad School of Business Management
S. No. 10/1, Ambegaon (BK), Pune - 411 041



Page 2 of 3

Scanned by CamScanner

SINHGAD KARANDAK 2020

NEON

RULES FOR EVENTS

1. Sinhgad Idol: (Solo Singing):
<ul style="list-style-type: none">• The contest would comprise of 02 rounds in Hindi/Marathi or English language.• 1st Round(3Min): <u>Classical OR Semi-Classical OR Bollywood/Western</u> (Participants Choice).• 2nd Round (3 Min): Judge's choice.• Total 06 minutes Per Participant.
2. Sinhgad Idol: (Duet Singing):
<ul style="list-style-type: none">• The contest would comprise of 02 rounds.• 1st Round (3 Min): <u>Classical OR Semi-classical OR Bollywood/Western</u> (Participants Choice).• 2nd Round (3 Min): Judge's Choice.• Total 06 minutes per team.
3. Solo Dance:
<ul style="list-style-type: none">• Participant may choose any one category of dance.• The categories include Western OR Folk OR Semi-Classical OR Bollywood.• 4 minutes time allotted per participant including setup time if any.
4. Group Dance:
<ul style="list-style-type: none">• One Team is Permissible per college.• Comprised of minimum 10 and maximum 12 students.• You may choose any one category of dance.• The categories include Western OR Folk OR Semi-Classical OR Bollywood.• 6 minutes time allotted including setup time if any.
5. Stage Play:
<ul style="list-style-type: none">• One Team is permissible per college.• Maximum 12 members including sound operator allowed in the team• The stage play can be based upon any theme.• Play should be in Marathi/Hindi / English .• Use of costumes and hand props allowed. No background set is allowed.• Background sound/music can be provided (mp3 format)• Play to be performed in general light. No special light effects allowed.• Marking to be based on acting, theme, direction, stage appearance, discipline, script, creativity, & overall impact• Use of vehicles, animals, use of obscene clothing or any other instruments are not allowed.• Maximum 15 Min. are allotted to each team.



Director

S.K.N. Sinhgad School of Business Management

S. No. 10/1, Ambegaon (BK), Pune - 411 041



Page 1 of 3

Scanned by CamScanner

SINHGAD KARANDAK -NEON 2020

Entry Fee for Inter-College Teams

Sr. No	Name of Event	Entry Fee
1	Fashion Show	1200
2	Group Dance	1200
3	Aegis of Rock	1500
4	Solo Dance	350
5	Solo Singing	350
6	Duet Singing	600
7	Mr. & Miss Sinhgad	300.
8	Stage Play	300

Prize Money for Inter College Events

Sr. No	Name of Event	Cash Prize Amount (in Rs)
1	Fashion Show	50,000
2	Group Dance	50,000
3	Solo Dance	20,000
4	Solo Singing	20,000
5	Duet Singing	30,000
6	Mr. & Miss Sinhgad	20,000
7	Stage Play	20,000
TOTAL =		2,10,000

1	Aegis of Rock	1,00,000
		50,000
	Total	1,50,000

Total Cash Prizes :-	Inter College	2,10,000
	Aegis Of Rock	1,50,000
	TOTAL =	3,60,000



Mr. Rohit M. Navale
Vice - President (HR), STES &
Chairman (Sinhgad Cultural Centre)
STES, Pune

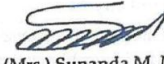

Dr. (Mrs.) Sunanda M. Navale
Founder Secretary, STES &
Secretary (Sinhgad Cultural Centre)
STES, Pune



Director
S.K.N. Sinhgad School of Business Management
S. No. 10/1, Ambegaon (BK), Pune - 411 041



SINHGAD KARANDAK - NEON 2020
Inter-campus Preliminary Round - Lonavala Campus

Date & Day	Venue	Sr No	Events	Campus Name	Teams	Time Allotted	Total Duration		Responsible College	Time of Event
							Minutes	Hours		
20.01.2020	Lonavala Campus	1	Sinhgad Idol Solo Singing	Inter Campus	7	4 Mins	28	00 Hrs 28 Mins	Sinhgad Institute of Technology	04.00 PM onwards
		2	Duet Singing	Inter Campus	7	15 Mins	105	01 Hrs 45 Mins	Smt. Kashibai Navale Sinhgad Institute of Technology and Science	
		3	Solo Dance	Inter Campus	7	6 mins	42	00 Hrs 42 Mins	Sinhgad Institute of Business Administration & Computer Application	
		4	Group Dance	Inter Campus	7	6 mins	42	00 Hrs 42 Mins	Sinhgad Institute of Business Administration & Computer Application	
21.01.2020	Lonavala Campus	1	Stage Play	Inter Campus	7	3 mins	21	00 Hrs 21 Mins	Sinhgad Institute of Pharmaceutical Sciences & Smt. Kashibai Navale College of Education & Training (B.Ed/D.Ed)	04.00 PM onwards
		2	Mr. & Ms. Sinhgad	Inter Campus	7	6 Mins	42	00 Hrs 42 Mins	Sinhgad Institute of Hotel Management & Catering Technology and Nivrutti Babaji Navale College of Commerce	
		3	Fashion Show	Inter Campus	7	9 Mins	63	00 Hrs 54 Mins	Sinhgad Institute of Technology and Sinhgad Institute of Business Administration & Computer Application	

Note: The colleges/institutes selected for the final round will be declared after the preliminary round based on respective event participation.

Scanned by CamScanner

Director

Mr. Rohit M. Navale
 Vice - President (HR), STES &
 Chairman (Sinhgad Cultural Centre)
 STES, Pune

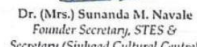
Dr. (Mrs.) Sunanda M. Navale
 Founder Secretary, STES &
 Secretary (Sinhgad Cultural Centre)
 STES, Pune

Sinhgad School of Business Management
 S. No. 10/1, Ambegaon (BK), Pune - 411 041



SINHGAD KARANDAK - NEON 2020
Inter-campus Preliminary Round - Kondhwa Campus

Date & Day	Venue	Sr No	Events	Campus Name	Teams	Time Allotted	Total Duration		Responsible College	Time of Event
							Minutes	Hours		
20.01.2020	Kondhwa Campus	1	Sinhgad Idol Solo Singing	Inter Campus	4	6	24	00 Hrs 24 Mins	Sinhgad Institute of Business Administration and Research	04.00 PM onwards
		2	Duet Singing	Inter Campus	4	6	24	00 Hrs 24 Mins	Sinhgad Institute of Business Administration and Research	
		3	Solo Dance	Inter Campus	4	4	16	00 Hrs 16 Mins	Sinhgad Academy of Engineering	
		4	Group Dance	Inter Campus	4	6	24	00 Hrs 24 Mins	Sinhgad Academy of Engineering	
21.01.2020	Kondhwa Campus	1	Stage Play	Inter Campus	4	15	60	1 Hrs 00 Mins	Smt. Kashibai Navale College of Pharmacy	04.00 PM onwards
		2	Mr. & Ms. Sinhgad	Inter Campus	4	3	12	00 Hrs 12 Mins	Sinhgad College of Arts, Commerce and Science	
		3	Fashion Show	Inter Campus	4	9	36	00 Hrs 36 Mins	Smt. Kashibai Navale College of Pharmacy and Sinhgad College of Arts, Commerce and Science	

Note: The colleges/institutes selected for the final round will be declared after the preliminary round based on respective event participation.

Scanned by CamScanner

Director

Mr. Rohit M. Navale
 Vice - President (HR), STES &
 Chairman (Sinhgad Cultural Centre)
 STES, Pune

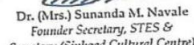
Dr. (Mrs.) Sunanda M. Navale
 Founder Secretary, STES &
 Secretary (Sinhgad Cultural Centre)
 STES, Pune

Sinhgad School of Business Management
 S. No. 10/1, Ambegaon (BK), Pune - 411 041



SINGHAD KARANDAK - NEON 2020
Inter-campus Preliminary Round - Warje Campus, Narhe Campus and Erandwane Campus
 (All events at Warje Campus)

Date & Day	Venue	Sr No	Events	Campus Name	Teams	Time Allotted	Total Duration		Responsible College	Time of Event
							Minutes	Hours		
20.01.2020	Warje Campus	1	Singhad Idol Solo Singing	Inter Campus	7	6	42	00 Hr 42 Mins	Singhad College of Arts, Science and Commerce, Narhe	04.00 PM onwards
		2	Duet Singing	Inter Campus	7	6	42	00 Hr 42 Mins	Singhad Institute of Management and Computer Application, Narhe	
		3	Solo Dance	Inter Campus	7	4	28	00 Hr 28 Mins	Singhad Institute of Pharmacy, Narhe	
		4	Group Dance	Inter Campus	7	6	42	00 Hr 42 Mins	Singhad Institute of Pharmacy, Narhe	
21.01.2020	Warje Campus	1	Stage Play	Inter Campus	7	15	105	01 Hr 45 Mins	Singhad Institute of Technology and Science and Singhad Business School (SBS) Erandwane	
		2	Mr. & Ms. Singhad	Inter Campus	7	3	21	00 Hr 21 Mins	RMD Singhad Technical Institute campus, Warje	
		3	Fashion Show	Inter Campus	7	9	63	01 Hr 03 Mins	Singhad Institute of Technology and Science Narhe and Smt. Kashibai Navale College of Commerce Erandwane Campus	

Note: The colleges/institutes selected for the final round will be declared after the preliminary round based on respective event participation.

 Mr. Rohit M. Navale
 Vice - President (HR), STES &
 Chairman (Singhad Cultural Centre)
 STES, Pune

 Dr. (Mrs.) Sunanda M. Navale
 Founder Secretary, STES &
 Secretary (Singhad Cultural Centre)
 STES, Pune

 Director

S.K.N. Singhad School of Business Management
 No. 10/1, Ambegaon (BK), Pune - 411 041



Scanned by CamScanner

SINGHAD KARANDAK - NEON 2020
Inter-campus Preliminary Round - Vadgaon Ambegaon Campus

Date & Day	Venue	Sr No	Events	Campus Name	Teams	Time Allotted	Total Duration		Responsible College	Time of Event
							Minutes	Hours		
20.01.2020	Vadgaon - Ambegaon Campus	1	Singhad Idol Solo Singing	Inter Campus	11	6 mins	66	01 Hrs 06 Mins	1) Smt. Kashibai Navale College of Architecture, Ambegaon Bk. Campus 2) Singhad Law College (SLC), Ambegaon Bk. Campus 3) Singhad Student Council (SSC)	04.00 PM onwards
		2	Solo Dance	Inter Campus	11	4 Mins	44	00 Hrs 44 Mins		
		3	Group Dance	Inter Campus	11	6 Mins	66	01 Hrs 06 Mins		
21.01.2020	Vadgaon - Ambegaon Campus	1	Duet Singing	Inter Campus	11	6 mins	66	01 Hrs 06 Mins		
		2	Stage Play	Inter Campus	11	15 Mins	165	02 Hrs 45 Mins		
22.01.2020	Vadgaon - Ambegaon Campus	1	Mr. & Ms. Singhad	Inter Campus	11	3 mins	33	00 Hrs 33 Mins		
		2	Fashion Show	Inter Campus	11	9 Mins	99	01 Hrs 39 Mins		

Note: The colleges/institutes selected for the final round will be declared after the preliminary round based on respective event participation.

 Mr. Rohit M. Navale
 Vice - President (HR), STES &
 Chairman (Singhad Cultural Centre)
 STES, Pune

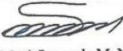
 Dr. (Mrs.) Sunanda M. Navale
 Founder Secretary, STES &
 Secretary (Singhad Cultural Centre)
 STES, Pune

 Director

S.K.N. Singhad School of Business Management
 No. 10/1, Ambegaon (BK), Pune - 411 041



Scanned by CamScanner



Sinhgad Technical Education Society's

SINHGAD SPORTS KARANDAK 2020



Lawn Tennis (Girls)

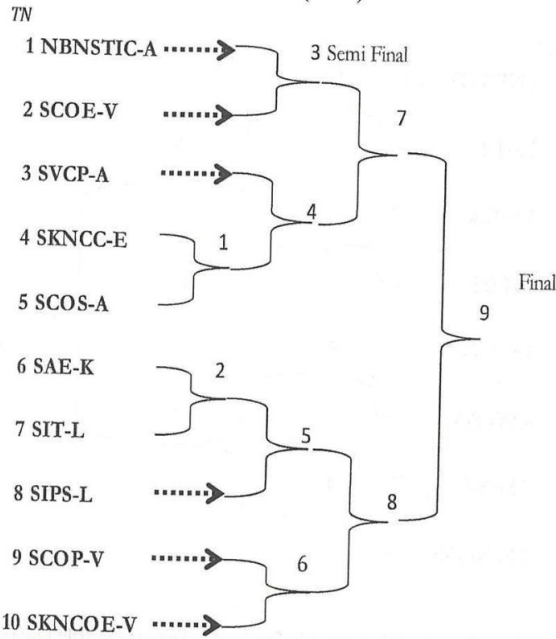

Match to match schedule for Lawn Tennis (Girls)

Match No.	Date	Time	Winner
1	13/01/2020	10.00 am to 10.30 am	
2	13/01/2020	10.30 am to 11.00 am	
Quarter Final Matches			
3	13/01/2020	11.00 am to 11.30 am	
4	13/01/2020	12.00 pm to 12.30 pm	
5	13/01/2020	12.30 pm to 1.00 pm	
6	13/01/2020	11.30 am to 12.00 pm	
Semi Final Matches			
7	13/01/2020	1.30 pm to 2.00 pm	
8	13/01/2020	2.00 pm to 2.30 pm	
Final Match			
9	13/01/2020	3.00 pm to 3.30 pm	

36

hinde
 Director
 S.K.N. Sinhgad School of Business Management
 S. No. 10/1, Ambegaon (BK), Pune - 411 041





Sinhgad Technical Education Society's

SINHGAD SPORTS KARANDAK 2020



Lawn Tennis Double (Boys)

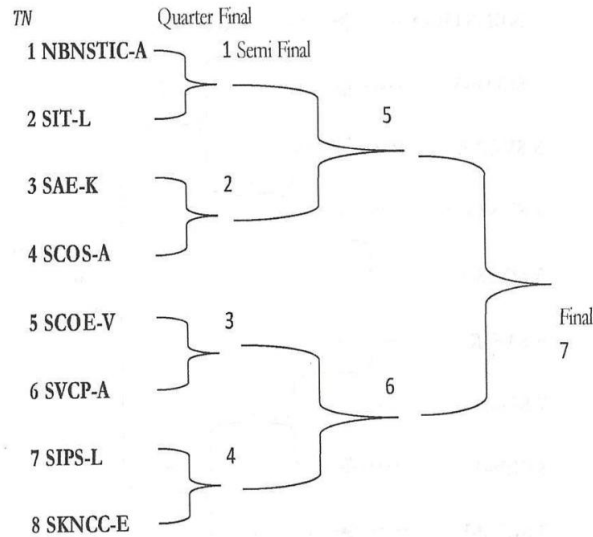

Match to match schedule for Lawn Tennis Double (Boys)

Match No.	Date	Time	Winner
First Round			
1.	15/01/2020	10.00 am to 10.30 am	
Quarter Final Matches			
2.	15/01/2020	10.30 am to 11.30 am	
3.	15/01/2020	11.30 am to 12.00 pm	
4.	15/01/2020	12.00 pm to 12.30 pm	
Semi Final Matches			
5.	15/01/2020	1.30 pm to 2.00 pm	
6.	15/01/2020	2.00 pm to 2.30 pm	
Final Match			
7.	15/01/2020	3.00 pm to 3.30 pm	

[Signature]

Director

S.K.N. Sinhgad School of Business Management
S. No. 10/1, Ambegaon (BK), Pune - 411 041

37





Sinhgad Technical Education Society's
SINHGAD SPORTS KARANDAK 2020



Lawn Tennis Double (Girls)

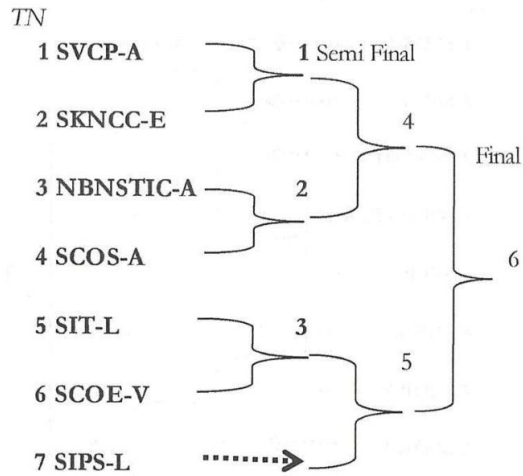

Match to match schedule for Lawn Tennis Double (Girls)

Match No.	Date	Time	Winner
First Round			
1.	14/01/2020	10.00 am to 10.30 am	
2.	14/01/2020	10.30 am to 11.00 am	
3.	14/01/2020	11.00 am to 11.30 am	
Semi Final Matches			
4.	14/01/2020	12.30 pm to 1.00 pm	
5.	14/01/2020	1.00 pm to 1.30 pm	
Final Match			
6.	14/01/2020	2.00 pm to 2.30 pm	

[Handwritten Signature]

Director

S.K.N. Sinhgad School of Business Management
 S. No. 10/1, Ambegaon (SK), Pune - 411 041





Sinhgad Technical Education Society's
SINHGAD SPORTS KARANDAK 2020



Lawn Tennis Mix (Double)

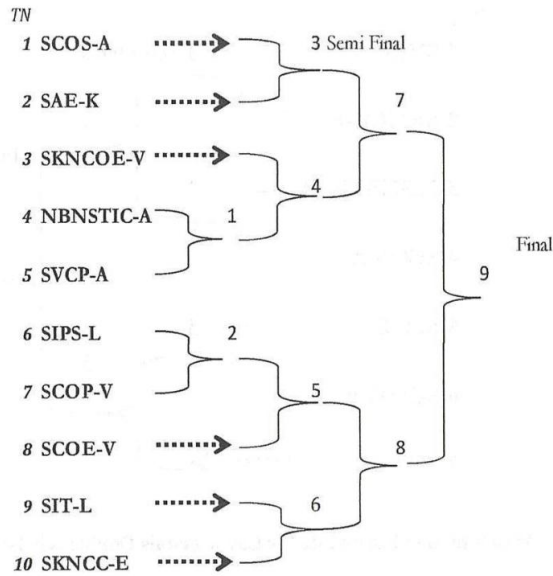

Match to match schedule for Lawn Tennis Mix Double

Match No.	Date	Time	Winner
First Round			
1.	16/01/2020	10.00 am to 10.30 am	
2.	16/01/2020	10.30 am to 11.00 am	
Quarter Final Matches			
3.	16/01/2020	11.00 am to 11.30 am	
4.	16/01/2020	12.00 pm to 12.30 pm	
5.	16/01/2020	12.30 pm to 1.00 pm	
6.	16/01/2020	11.30 am to 12.00 pm	
Semi Final Matches			
7.	16/01/2020	1.30 pm to 2.00 pm	
8.	16/01/2020	2.00 pm to 2.30 pm	
Final Match			
9.	16/01/2020	3.00 pm to 3.30 pm	

hike
 Director

S.K.N. Sinhgad School of Business Management
 S. No. 10/1, Ambegaon (BK), Pune - 411 041





Sinhgad Technical Education Society's

SINHGAD SPORTS KARANDAK 2020



Kabaddi (Boys)

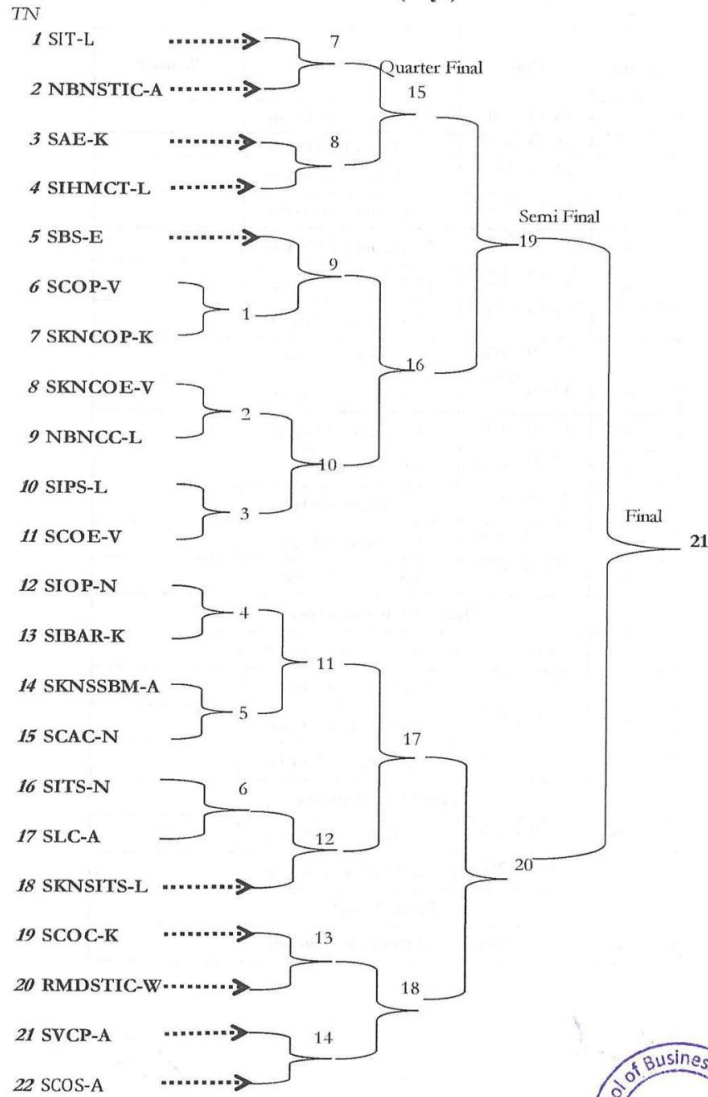

40

Director

S.K.N. Sinhgad School of Business Management
S. No. 10/1, Ambegaon (BK), Pune - 411 041





Sinhgad Technical Education Society's



SINHGAD SPORTS KARANDAK 2020

Match to match schedule for Kabaddi (Boys)

Match No.	Date	Time	Winner
1.	13/01/2020	10.00 am to 10.45 am	
2.	13/01/2020	10.00 am to 10.45 am	
3.	13/01/2020	10.45 am to 11.30 am	
4.	13/01/2020	10.45 am to 11.30 am	
5.	13/01/2020	11.30 am to 12.15 pm	
6.	13/01/2020	11.30 am to 12.15 pm	
7.	13/01/2020	12.15 pm to 1.00 pm	
8.	13/01/2020	12.15 pm to 1.00 pm	
9.	13/01/2020	1.30 pm to 2.15 pm	
10.	13/01/2020	1.30 pm to 2.15 pm	
11.	13/01/2020	2.15 pm to 3.00 pm	
12.	13/01/2020	2.15 pm to 3.00 pm	
13.	13/01/2020	3.00 pm to 3.45 pm	
14.	13/01/2020	3.00 pm to 3.45 pm	
Quarter Final Matches			
15.	14/01/2020	10.00 am to 10.45 am	
16.	14/01/2020	10.00 am to 10.45 am	
17.	14/01/2020	10.45 am to 11.30 am	
18.	14/01/2020	10.45 am to 11.30 am	
Semi Final Matches			
19.	14/01/2020	11.30 am to 12.15 pm	
20.	14/01/2020	12.15 pm to 1.00 pm	
Final Match			
21.	14/01/2020	2.00 pm to 3.00 pm	

Director

S.K.N. Sinhgad School of Business Management
S. No. 10/1, Ambegaon (BK), Pune - 411 041

41





Sinhgad Technical Education Society's

SINHGAD SPORTS KARANDAK 2020



Kabaddi (Girls)

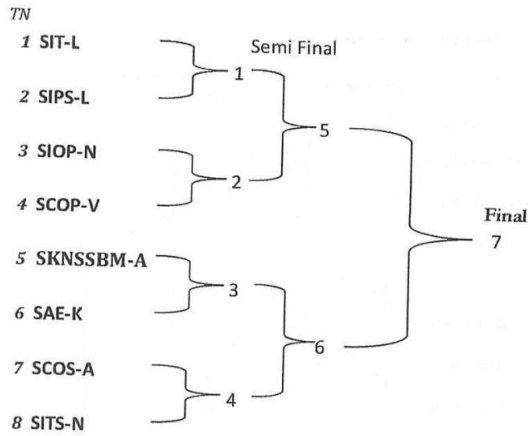

Match to match schedule for Kabaddi (Girls)

Match No.	Date	Time	Winner
First Round			
1.	13/01/2020	10.00 am to 10.30 am	
2.	13/01/2020	10.30 am to 11.00 am	
3.	13/01/2020	11.00 am to 11.30 am	
4.	13/01/2020	11.30 am to 12.00 pm	
Semi Final Matches			
5.	13/01/2020	1.00 pm to 1.30 pm	
6.	13/01/2020	1.30 pm to 2.00 pm	
Final Match			
7.	13/01/2020	3.00 pm to 4.00 pm	

hish
Director

S.K.N. Sinhgad School of Business Management
S. No. 10/1, Ambegaon (BK), Pune - 411 041





Sinhgad Technical Education Society's

SINHGAD SPORTS KARANDAK 2020



Chess (Boys)

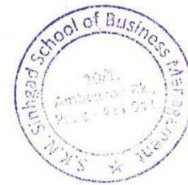
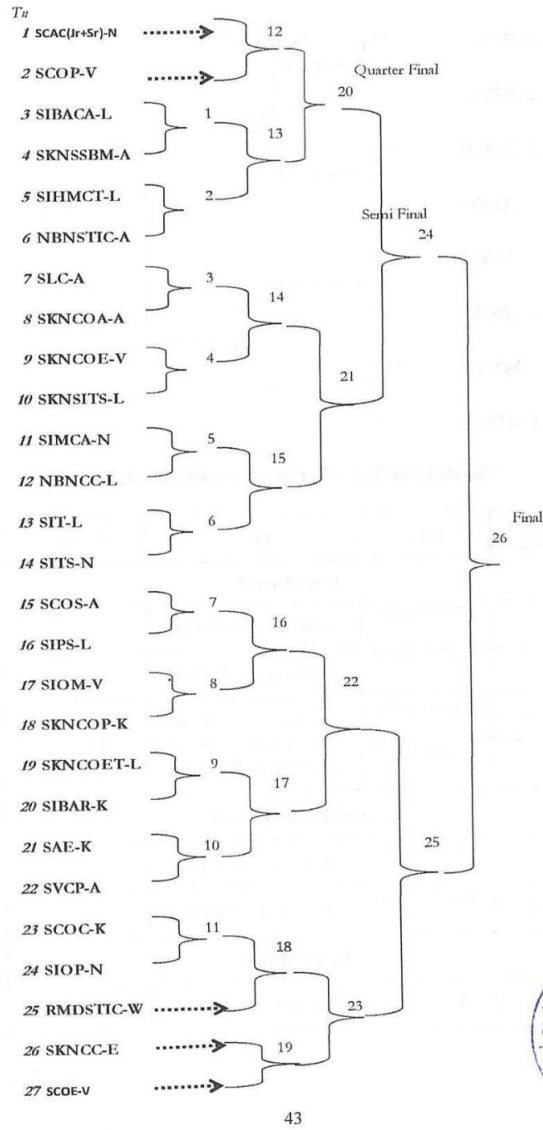

hish
 Director
 S.K.N. Sinhgad School of Business Management
 S. No. 10/1, Ambegaon (BK), Pune - 411 041



Sinhgad Technical Education Society's

SINHGAD SPORTS KARANDAK 2020



Match to match schedule for Chess (Boys)

Match No.	Date	Time	Winner
First Round			
1.	13/01/2020	10.00 am to 10.30 am	
2.	13/01/2020	10.00 am to 10.30 am	
3.	13/01/2020	10.00 am to 10.30 am	
4.	13/01/2020	10.30 am to 11.00 am	
5.	13/01/2020	10.30 am to 11.00 am	
6.	13/01/2020	10.30 am to 11.00 am	
7.	13/01/2020	11.00 am to 11.30 am	
8.	13/01/2020	11.00 am to 11.30 am	
9.	13/01/2020	11.00 am to 11.30 am	
10.	13/01/2020	11.30 am to 12.00 pm	
11.	13/01/2020	11.30 am to 12.00 pm	
12.	13/01/2020	11.30 am to 12.00 pm	
13.	13/01/2020	1.00 pm to 1.30 pm	
14.	13/01/2020	1.00 pm to 1.30 pm	
15.	13/01/2020	1.00 pm to 1.30 pm	
16.	13/01/2020	1.30 pm to 2.00 pm	
17.	13/01/2020	1.30 pm to 2.00 pm	
18.	13/01/2020	1.30 pm to 2.00 pm	
19.	13/01/2020	2.00 pm to 2.30 pm	
Quarter Final Matches			
20.	13/01/2020	2.30 pm to 3.00 pm	
21.	13/01/2020	2.30 pm to 3.00 pm	
22.	13/01/2020	3.00 pm to 3.30 pm	
23.	13/01/2020	3.00 pm to 3.30 pm	
Semi Final Matches			
24.	14/01/2020	10.00 am to 10.30 am	
25.	14/01/2020	10.00 am to 10.30 am	
Final Match			
26.	14/01/2020	11.00 am to 11.30 am	

Director
S.K.N. Sinhgad School of Business Management
S. No. 10/1, Ambegaon (BK), Pune - 411 041

44





Sinhgad Technical Education Society's
SINHGAD SPORTS KARANDAK 2020



Chess (Girls)

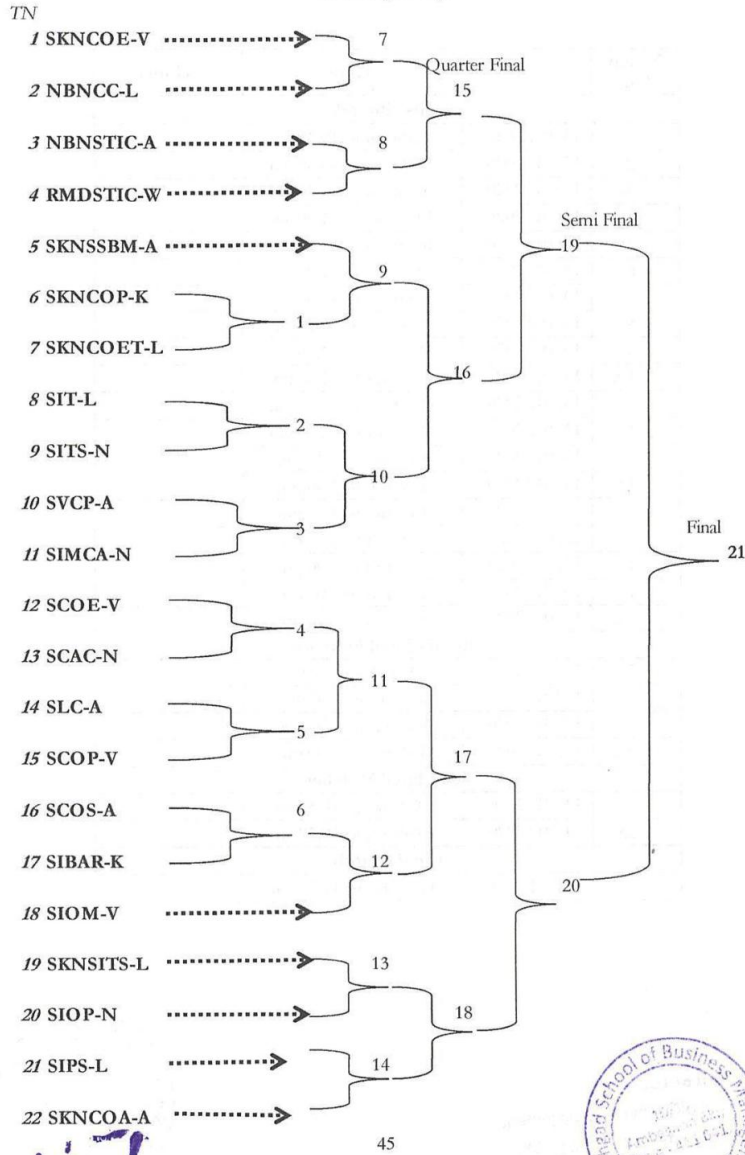

S.K.N.
Director

S.K.N. Sinhgad School of Business Management
S. No. 10/1, Ambegaon (BK), Pune - 411 041





Sinhgad Technical Education Society's

SINHGAD SPORTS KARANDAK 2020



Match to match schedule for Chess (Girls)

Match No.	Date	Time	Winner
First Round			
1.	15/01/2020	10.00 am to 10.30 am	
2.	15/01/2020	10.00 am to 10.30 am	
3.	15/01/2020	10.00 am to 10.30 am	
4.	15/01/2020	10.30 am to 11.00 am	
5.	15/01/2020	10.30 am to 11.00 am	
6.	15/01/2020	10.30 am to 11.00 am	
7.	15/01/2020	11.00 am to 11.30 am	
8.	15/01/2020	11.00 am to 11.30 am	
9.	15/01/2020	11.00 am to 11.30 am	
10.	15/01/2020	11.30 am to 12.00 pm	
11.	15/01/2020	11.30 am to 12.00 pm	
12.	15/01/2020	11.30 am to 12.00 pm	
13.	15/01/2020	1.00 pm to 1.30 pm	
14.	15/01/2020	1.00 pm to 1.30 pm	
Quarter Final Matches			
15.	15/01/2020	1.00 pm to 1.30 pm	
16.	15/01/2020	1.30 pm to 2.00 pm	
17.	15/01/2020	1.30 pm to 2.00 pm	
18.	15/01/2020	1.30 pm to 2.00 pm	
Semi Final Matches			
19.	15/01/2020	2.30 pm to 3.00 pm	
20.	15/01/2020	2.30 pm to 3.00 pm	
Final Match			
21.	15/01/2020	3.30 pm to 4.00 am	

Director

S.K.N. Sinhgad School of Business Management
S. No. 10/1, Ambegaon (BK), Pune - 411 041





Sinhgad Technical Education Society's

SINHGAD SPORTS KARANDAK 2020



Badminton (Boys)

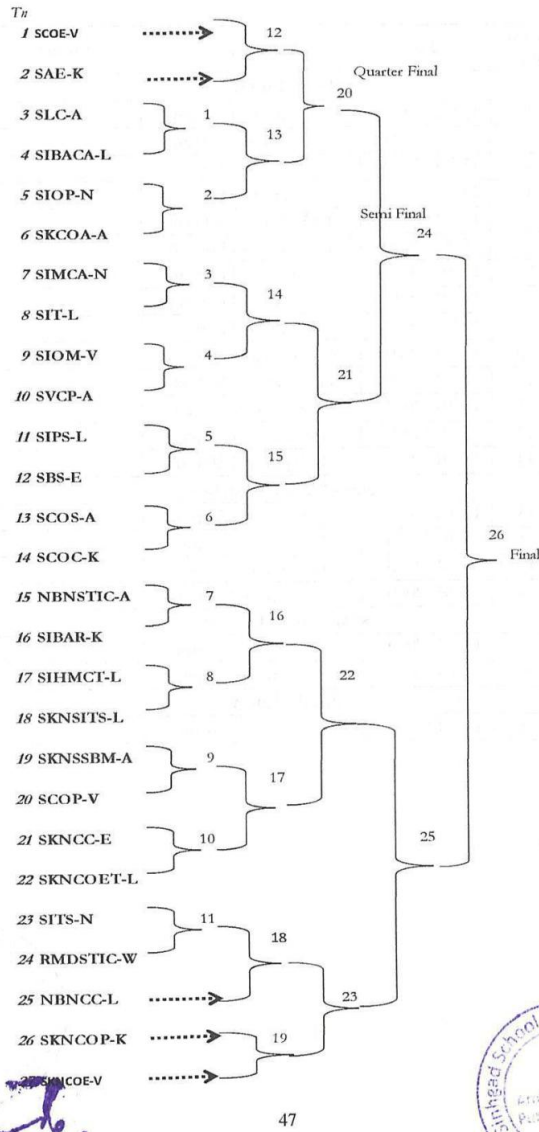

Director

S.K.N. Sinhgad School of Business Management
S. No. 10/1, Ambegaon (BK), Pune - 411 041





Sinhgad Technical Education Society's

SINHGAD SPORTS KARANDAK 2020



Match to match schedule for Badminton (Boys)

Match No.	Date	Time	Winner
First Round			
1.	21/01/2020	10.00 am to 10.30 am	
2.	21/01/2020	10.00 am to 10.30 am	
3.	21/01/2020	10.30 am to 11.00 am	
4.	21/01/2020	10.30 am to 11.00 am	
5.	21/01/2020	11.00 am to 11.30 am	
6.	21/01/2020	11.30 am to 12.00 pm	
7.	21/01/2020	11.30 am to 12.00 pm	
8.	21/01/2020	12.00 pm to 12.30 pm	
9.	21/01/2020	12.00 pm to 12.30 pm	
10.	21/01/2020	1.00 pm to 1.30 pm	
11.	21/01/2020	1.00 pm to 1.30 pm	
12.	21/01/2020	1.30 pm to 2.00 pm	
13.	21/01/2020	1.30 pm to 2.00 pm	
14.	21/01/2020	2.00 pm to 2.30 pm	
15.	21/01/2020	2.00 pm to 2.30 pm	
16.	21/01/2020	2.30 pm to 3.00 pm	
17.	21/01/2020	2.30 pm to 3.00 pm	
18.	21/01/2020	3.00 pm to 3.30 pm	
19.	21/01/2020	3.00 pm to 3.30 pm	
Quarter Final Matches			
20.	22/01/2020	10.00 am to 10.30 am	
21.	22/01/2020	10.30 am to 11.00 am	
22.	22/01/2020	11.00 am to 11.30 am	
23.	22/01/2020	11.30 am to 12.00 pm	
Semi Final Matches			
24.	22/01/2020	1.00 pm to 1.30 pm	
25.	22/01/2020	1.30 pm to 2.00 pm	
Final Match			
26.	22/01/2020	2.30 pm to 3.00 pm	

Director
S.K.N. Sinhgad School of Business Management
S. No. 10/1, Ambegaon (BK), Pune - 411 041





Sinhgad Technical Education Society's

SINHGAD SPORTS KARANDAK 2020



Badminton (Girls)

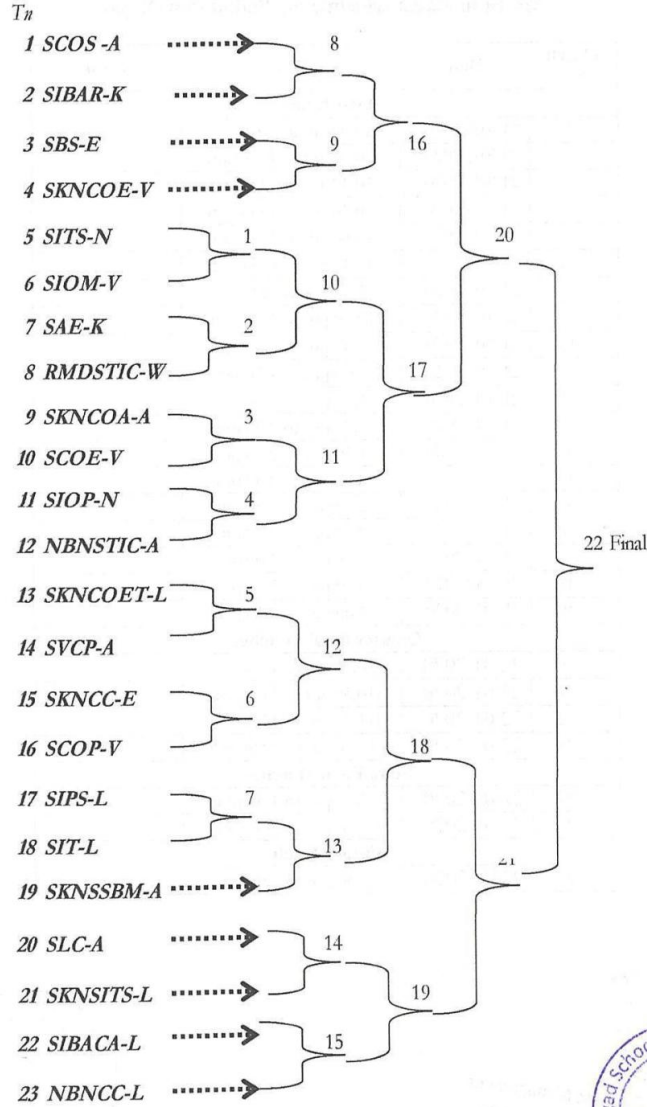

[Signature]
Director

S.K.N. Shhgad School of Business Management
 S. No. 10/1, Ambegaon (BK), Pune - 411 041





Sinhgad Technical Education Society's

SINHGAD SPORTS KARANDAK 2020



Match to match schedule for Badminton (Girls)

Match No.	Date	Time	Winner
First Round			
1.	23/01/2020	10.00 am to 10.30 am	
2.	23/01/2020	10.00 am to 10.30 am	
3.	23/01/2020	10.30 am to 11.00 am	
4.	23/01/2020	10.30 am to 11.00 am	
5.	23/01/2020	11.00 am to 11.30 am	
6.	23/01/2020	11.30 am to 12.00 pm	
7.	23/01/2020	11.30 am to 12.00 pm	
8.	23/01/2020	12.00 pm to 12.30 pm	
9.	23/01/2020	12.00 pm to 12.30 pm	
10.	23/01/2020	12.30 pm to 1.00 pm	
11.	23/01/2020	12.30 pm to 1.00 pm	
12.	23/01/2020	1.00 pm to 1.30 pm	
13.	23/01/2020	1.00 pm to 1.30 pm	
14.	23/01/2020	1.30 pm to 2.00 pm	
15.	23/01/2020	1.30 pm to 2.00 pm	
Quarter Final Matches			
16.	23/01/2020	2.00 pm to 2.30 pm	
17.	23/01/2020	2.00 pm to 2.30 pm	
18.	23/01/2020	2.30 pm to 3.00 pm	
19.	23/01/2020	2.30 pm to 3.00 pm	
Semi Final Matches			
20.	23/01/2020	3.00 pm to 3.30 pm	
21.	23/01/2020	3.00 pm to 3.30 pm	
Final Match			
22.	23/01/2020	4.00 pm to 4.30 pm	

Director

S.K.N. Sinhgad School of Business Management
S. No. 10/1, Ambegaon (BK), Pune - 411 041





Campus	S.N.	Institute Name	Sports In charge	Physical Director/ Sports Teacher	Contact No.	E mail Id
Vadgaon(Bk)	1	SCOE-V	Mr. Vishal Honmane Mr. N. M. Dharmadhikari	Mr. Vishal Honmane	8600000488 9130090352	vrhonmane.scoe@sinhgad.edu Nmdharmadhikari.scoe@sinhgad.edu
	2	SKNCOE-V	Mr. G.B. Firame		7767030499	gbfirame@sinhgad.edu
	3	SCOP-V	Mr. S.K. Mandlik Mrs. Kiran Y Bhokare		9850187167 7038806176	satish4004@gmail.com kiran.katkar76@gmail.com
	4	SIOM- V	Mr. Pradip Thombare Mr. Rahul Dwivedi		9833079377 9881079785	pradip.thombare@sinhgad.edu rdwivedi.siom@sinhgad.edu
Ambegaon(Bk)	5	NBN-SSOE-A	Prof. K. S. Mahajan Prof. G. V. Pise		8087142445 9011958990	Kamlesh.mahajan.nbssoe@sinhgad.edu Gautam.pise.nbssoe@sinhgad.edu
	6	SKN-SSBM- A	Prof. Pravin Bodade Prof. Sanchit Pansare Prof. Kalpana Sayankar		9890081231 7620589900 9960027776	pravinbodade.sknsbm@sinhgad.edu Sanchitpansare.sknsbm@sinhgad.edu Kalpanasayankar.sknsbm@sinhgad.edu
	7	SVCP-A	Mr. S. G. Bhosale Mrs. Shailaja Ahirao		9011741041 7972545985	shaileshbhosale@sinhgad.edu Shailaja.ahirao@gmail.com
	8	SLC-A	Mr. K.P. Raskar	Mr. K.P. Raskar	9730365352	kishor.raskar252@gmail.com
	9	SCOS -A	Prof. Kailas Thakur Mr. Santosh Navale	Mr. Santosh Navale	9011667346 9881046721	kdthakur.scoas@sinhgad.edu santosh.n.scos@sinhgad.edu
	10	SKNCOA-A	Ar. Amol Dahivadkar Ar. Harshavardhan Wakode		8788640320 9096186788	amoladahivadkar@gmail.com Harshavardhan.wakode@gmail.com

Hinde
Director

S.K.N. Sinhgad School of Business Management
S. No. 10/1, Ambegaon (BK), Pune - 411 041

51



Kondhawa	11	SAE-K	Ms. Priti Daware	Ms. Priti Daware	8806949186	pgdaware.sae@sinhgad.edu
	12	SIBAR-K	Mr. Vishal Sahu Anil Sharma		9975619341 8390071667	vishalsahu@sinhgad.edu Anilsharma_sibar@sinhgad.edu
	13	SKNCOP-K	Mr. Ramesh Gadekar Ms. Priyanka Nigade		9881254792 9766589644	ramesh_gadekar_skncop@sinhgad.edu priyanka.nigade.skncop@sinhgad.edu
	14	SCOC-K	Mr. Nilesh Kela Mr. Sandesh Bansode		7030651444 9067579068	Nileshkela.jr@sinhgad.edu sandesh.bansode.scoc@sinhgad.edu
Narhe	15	SITS- N	Prof. Sachin Velapure Mr. Sagar Tingre		9623300626 9545479191	spvelapure_sits@sinhgad.edu pinutingare@gmail.com
	16	SIMCA-N	Mr. Rajesh Gawali Mr. Maruti Dhanwade Mr. Prashant Chordiya		9422321615 7219425500 8788669800 9595992354	rajeshgawali@sinhgad.edu msdhanwade.siom@sinhgad.edu prashantchordiya@sinhgad.edu
	17	SIOP-N	Mr. A.A. Bidkar		9922417762	abhijeet.bidkar@gmail.com
	18	SCAC(Jr+Sr)-N	Mr. A.C. Nagarkar	Mr. A.C. Nagarkar	9421945335 9403932132	ajit.nagarkar.scoac@sinhgad.edu

Hinde
Director

S.K.N. Sinhgad School of Business Management
S. No. 10/1, Ambegaon (BK), Pune - 411 041

52





Sinhgad Technical Education Society's

**SINHGAD SPORTS KARANDAK 2020**

Lonawala	19	SIBACA- L	Nilesh Patil		8805249502	nileshpatil.sibaca@sinhgad.edu
	20	SIT-L	Ms. Vaishali Jadhav	Ms. Vaishali Jadhav	9821162267	vbiadhav.sit@sinhgad.edu
			Kailash karnekar		9527425249	viadhav27july@gmail.com
			Suraj B Patil		8421380138	kailash_karnekar_sit@sinhgad.edu
					8421380138	suraj.patil.sit@sinhgad.edu
	21	SKNSITS-L	Mr. Roshan Shinde		8390959794	rss.sknsits@sinhgad.edu
			Mr.Siddheshwar Nikam		9168661843	siddheshwarnikam@gmail.com
	22	SIHMCT-L	Prof. Chandrakant Deshmukh		8411867140	cmdeshmukh.sihmct@sinhgad.edu
23	NBNCCS-L	Mr. Anil Kamlapure	Mr. Anil Kamlapure	8421760276	anil.nbnccoc@sinhgad.edu	
24	SIPS-L	Mr Kulkarni Aniruddha		7773962524	askulkarni.sips@sinhgad.edu	
25	SKNCOET (B.Ed)-L	Mr. Suhas Daphal		9730581058	suhas.daphal@sinhgad.edu	
		Prof.Santosh J.Shinde		9975999996	shinde.santosh@sinhgad.edu	
Erandwane	26	SKNCC-E	Prof. Abhijeet Garg	Prof. Abhijeet Garg	9860381968	abhijeetgarg16.skncoc@sinhgad.edu
	27	SBS-E	Prof. Prashant Kotasthane		9766533465	pmkotas.sbs@sinhgad.edu
Warje	28	RMD-STIC-W	Mr. Sujeet Kumar Kandgire	Mr. Sujeet Kumar Kandgire	9421454316	sujeetkumarkandgire.rmdssoe@sinhgad.edu
International	SISC	Mr. Somnath Ingole		9881627899	sisc@sinhgad.edu	
		Mrs. Uttara Barale		8668371618	uttara.barale.sdc@sinhgad.edu	
				9890155699		

Director

S. K. M. Sinhgad School of Business Management
S. No. 10/1, Ambegaon (RG), Pune - 411 041

53



Singhad Sports Karandak 2020

Singhad Technical Education Society's



Registration Form

Name and campus of the participating college: **S.K.M. Singhad School of Business Management**

Name of the sports event: **Athletic Running 100m (galls)**

Name of Team Manager: **Manoj Kulkarni**

Grade Number only: **3360027776**

Contact No: **9088448211**

College Office Number: **3360027776**

Name of the Team Captain: **Komal Patil**

Contact No: **9088448211**

Sr.	Name of the Player	Class	Sr.	Name of the Player	Class/Year
01	Komal Ranesh Patil MBA I	09			
02	Manoj Mahesh Pradhane MBA I	10			
03	Chaitrali Kavayate Kulkarni MBA I	11			
04		12			
05		13			
06		14			
07		15			
08		16			

I hereby declare that all of the above players are the bonafide students of our college for current academic year.

Captain Sign

Team Manager Sign

Signature of the Principal

Director

S.K.M. Singhad School of Business Management
 P. No. 10/1, Ambegaon (S), Pune - 411 041



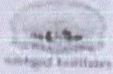

Sinhgad Technical Education Society's



Sinhgad Sports Karandak 2020

Registration Form

Name and Campus of the participating college:	SKN Sinhgad School of Business Management
Name of the Sports event:	Girls Athletics Relay
Details of Team Manager (Staff Member only):	Name: Ajida More / Mangula Bhudipala
	Contact No: 9515534004 / 9881781433
	College Office Number: 020-24354036
Name of the Team Captain:	Name: Komal Patel Contact No: 7058748711

Names of the Players

Sr. No.	Name of the Player	Class/Year	Sr. No.	Name of the Player	Class/Year
01	Rajini Dady	E	09		
02	Mansi Phadkar	E	10		
03	Charita Etkarni	E	11		
04	Komal Patel	A	12		
05			13		
06			14		
07			15		
08			16		

Declaration: We the undersigned, hereby declare that all of the above players are the bonafide students of our college for current academic year.

Komal Patel
Captain Sign

Ajida More
Team Manager Sign



[Signature]
Signature of the Principal

[Signature]
Director



SKN Sinhgad School of Business Management
S. No. 10/1, Ambalgaon Bk., Pune - 411 041



S.K.M. Singhad School of Business Management
S. No. 10/1, Ambegaon (Bk), Pune - 411 041

Director

[Signature]



Team Manager Sign

[Signature]

Signature of the Principal

[Signature]

of our college for current academic year.

Declaration: We the undersigned, hereby declare that all of the above players are the bonafide students

Sr. No.	Name of the Player	Class	Sr. No.	Name of the Player	Class	Year
01	Dipak Bordane	MBA I	09	Mohammad Nadiem	MBA I	
02	Prasad Kamble	MBA I (N)	10	Rushikesh Pawar	MBA I	
03	Omkar Durghis	MBA I	11	Ganesh Gavali	MBA I	
04	Mohan Kale	MBA I	12	Onkar Gadole	MBA I	
05	Rajan Nalavade	MBA I	13			
06	Vaidhyan Phadare	MBA I	14			
07	Sunny Mandhate	MBA I	15			
08	Pratik Dhong	MBA I	16			

Names of the Players

Name and Campus of the participating college:	S.K.M. Singhad School of Business Management
Name of the sports event:	Kabaddi (Boys)
Details of Team Manager (Staff Member only):	Name: Magdal Yadav Contact No: 9850511715
Name of the Team Captain:	Name: Dipak Bordane Contact No: 9830241190
College Office Number:	

Registration Form

Singhad Sports Karandak 2020

Singhad Technical Education Society's





Sinhgad Technical Education Society's

Sinhgad Sports Karandak 2020



Proposed Sports Events, Dates and Responsibilities

International Student Matches (07-14 Jan 2020/ 8 Days)

Sr. No.	Sport Event	Proposed Dates From-to	Proposed Venue	Responsible Institutes
1	Cricket (Boys)	07-09 Jan 2020	Cricket Ground, Lonavala Campus	SIT-L & SITS-N
2	Football (Boys)	10-11 Jan 2020	Football Grounds, Lonavala Campus	SKNSITS-L & SIOM-V
3	Football (Girls)	10-11 Jan 2020	Football Ground, Lonavala Campus	SKNSITS-L & SIOM-V
4	Volleyball (Boys)	13-14 Jan 2020	Volleyball Court, Lonavala Campus	SKNCOET-L & SKNSSBM - A
5	Basketball (Boys)	13-14 Jan 2020	Basketball Court, Lonavala Campus	NBNCC-L & SLC-A

Inter-Collegiate (Invitational) Matches (08 Jan 2020-20 Jan 2020/ 13 Days)

Sr. No.	Sport Event	Proposed Dates From-to	Proposed Venue	Responsible Institutes
1	Cricket (Boys)	08 -20 Jan 2020	STES Cricket Ground, Vadgaon Campus	SCOE-V & SKNCOE-V
2	Football (Boys)	13-16 Jan 2020	Football Grounds, Lonavala Campus	SKNSITS-L & SIOM-V
3	Volleyball (Boys)	08 - 10 Jan 2020	School Volleyball Court, RMD-STIC Warje	RMD-STIC- W & SCOC-K
4	Basketball (Boys)	08 - 13 Jan 2020	Basketball Court Kondhwa Campus	SIBAR-K & SKNCOP-K

Dr. (Mrs) Sunanda M. Navale
Founder Secretary, STES
Secretary Sinhgad Sport Club & Cultural Centre

Mr. Rohit M. Navale
Vice. President (HR), STES
Chairman, Sinhgad Sport Club & Cultural Centre

Director
S.K.N. Sinhgad School of Business Management
S. No. 10/1, Ambegaon (BK), Pune - 411 041



Scanned by CamScanner



Sinhgad Technical Education Society's



Sinhgad Sports Karandak 2020

STES Inter-Campus Sports Events (13 Jan 2020 - 28 Jan 2020/ 16 Days)

Sr. No	Sport Event	Proposed Dates From-to	Proposed Venue	Responsible Institutes
1	Cricket (Boys)	13 - 24 Jan 2020	Cricket Ground, Lonavala Campus	SIT-L & SITS-N
2	Cricket (Girls)	21 - 28 Jan 2020	STES Cricket Ground, Vadgaon Campus	SCOE-V & SKNCOE-V
3	Football (Boys)	17 - 21 Jan 2020	STES Football Grounds Lonavala Campus	SKNSITS-L & SAE-K
4	Football (Girls)	21 Jan 2020	STES Football Ground-2 Lonavala Campus	SKNSITS-L & SAE-K
5	Volleyball (Boys)	13 - 16 Jan 2020	School Volleyball Court. RMD- STIC Warje	RMD-STIC- W & SLC-A
6	Volleyball (Girls)	17-20 Jan 2020	School Volleyball Court. RMD- STIC Warje	RMD-STIC- W & SKNSSBM-A
7	Basketball (Boys)	15 - 17 Jan 2020	Basketball Court. Lonavala Campus	SIBACA-L & SLC-A
8	Basketball (Girls)	14 Jan 2020	Basketball Court. Kondhwa Campus	SCOC-K
9	Table Tennis (Boys)	13-14 Jan 2020	SIMCA, Narhe (Top) Campus	SIMCA- N & SCAC-N
10	Table Tennis (Girls)	13-14 Jan 2020	SIOP, Narhe (Top) Campus	SIOP- Narhe
11	Table Tennis - Doubles (Boys)	15-16 Jan 2020	SIMCA, Narhe (Top) Campus	SIMCA- N & SCAC-N
12	Table Tennis - Doubles (Girls)	15 Jan 2020	SIOP, Narhe (Top) Campus	SIOP- Narhe
13	Table Tennis Mixed Doubles	17 Jan 2020	SIMCA, Narhe (Top) Campus	SIMCA- N & SCAC-N
14	Lawn Tennis (Boys)	13-14 Jan 2020	Lawn Tennis Court , Lonavala Campus	SIBACA-L & SBS-E
15	Lawn Tennis (Girls)	13 Jan 2020	Lawn Tennis Court, Vadgaon Campus	SCOP-V & SVCP-A

Dr. (Mrs) Sunanda M. Navale
 Founder Secretary, STES
 Secretary, Sinhgad Sport Club & Cultural Centre

Mr. Rohit M. Navale
 Vice. President (HR), STES
 Chairman, Sinhgad Sport Club & Cultural Centre

Cont...

Director

S.K.N. Sinhgad School of Business Management
 S. No. 10/1, Ambegaon (BK), Pune - 411 041



Scanned by CamScanner



Sinhgad Technical Education Society's



Sinhgad Sports Karandak 2020

Sr. No	Sport Event	Proposed Dates From-to	Proposed Venue	Responsible Institutes
16	Lawn Tennis - Doubles (Boys)	15 Jan 2020	Lawn Tennis Court, Lonavala Campus	SIBACA-L & SBS-E
17	Lawn Tennis - Doubles (Girls)	14 Jan 2020	Lawn Tennis Court, Vadgaon Campus	SCOP-V & SVCP-A
18	Lawn Tennis - Mixed Double	16 Jan 2020	Lawn Tennis Court, Vadgaon Campus	SCOP-V & SVCP-A
19	Kabaddi (Boys)	13-14 Jan 2020	Kabaddi ground, Lonavala	SAE-K & SIHMCT-L
20	Kabaddi (Girls)	13 Jan 2020	RMD-STIC- Warje Campus	RMDSTIC-W & SIBAR-K
21	Chess (Boys)	13-14 Jan 2020	SKNCOA, Ambegaon Campus	SKNCOA-Ambegaon
22	Chess (Girls)	15 Jan 2020	SKNCOA, Ambegaon Campus	SKNCOA-Ambegaon
23	Swimming (Boys)	13 Jan 2020	Swimming Pool, Lonavala Campus	SIHMCT- L & SKNCC-E
24	Swimming (Girls)	14 Jan 2020	Swimming Pool, Lonavala Campus	SIHMCT- L & SKNCC-E
25	Athletics - Running 100 m (Boys)	13 Jan 2020	Athletic tracks, Lonavala Campus	NBNCC-L & SIPS-L
26	Athletics - Running 100 m (Girls)	14 Jan 2020	Athletic tracks, Lonavala Campus	NBNCC-L & SIPS-L
27	Athletics - Relay (4x100m) (Boys)	13 Jan 2020	Athletic tracks, Lonavala Campus	NBNCC-L & SIPS-L
28	Athletics - Relay (4x100m) (Girls)	14 Jan 2020	Athletic tracks, Lonavala Campus	NBNCC-L & SIPS-L
29	Badminton(Boys)	20-22 Jan 2020	Indoor sports complex, Lonavala Campus	SIPS-L & SKNCOP-K
30	Badminton (Girls)	23-25 Jan 2020	Indoor sports complex, Lonavala Campus	SIPS-L & SKNCOP-K

Dr. (Mrs) Sunanda M. Navale
Founder Secretary, STES
Secretary, Sinhgad Sport Club & Cultural Centre

Mr. Rohit M. Navale
Vice. President (HR), STES
Chairman, Sinhgad Sport Club & Cultural Centre

Director

S.K.N. Sinhgad School of Business Management
S. No. 10/1, Ambegaon (BK), Pune - 411 041



Scanned by CamScanner

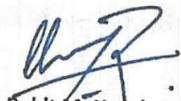

Table of various Responsibilities

Sr. No.	Responsibility	Institute
1	<ul style="list-style-type: none"> Overall Co-ordination. Registration Forms. Distribution, Collection & Analysis. Rule Book Preparation & approval. Drawing of Lots. Submission of Final report. 	NBNSTIC-A
2	<ul style="list-style-type: none"> Overall Co-ordination. Approval for Requirements & Design of Trophies, Medals, Flex, Flyer, Certificates. Purchase orders & Procurement. Distribution & Maintaining Records. Submission of Daily report. 	SCOS-A
3	<ul style="list-style-type: none"> Overall coordination of activities in respective campus Ensuring readiness of grounds & other facilities Ensuring smooth conduction of events in the campus. Submission of Daily report 	NBNSTIC-V SCOS-A SIMCA-N RMDSTIC-W SKNCOP-K SAE-K SKNSITS-L
4	Overall coordination of Bus Transport arrangements with toll payments for Vadgaon-Ambegaon Campus.	SKNCOE-V
5	Overall coordination of Bus Transport arrangements with toll payments for Warje Campus.	RMD STIC-W
6	Overall coordination of Bus Transport arrangements with toll payments for Kondhwa & Erandwane Campus.	SAE-K
7	Overall coordination of Bus Transport arrangements with toll payments for Narhe Campus.	SITS-N
8	Overall coordination of Bus Transport arrangements with toll payments for Lonavala Campus.	SKNSITS-L

Dr. (Mrs) Sunanda M. Navale
 Founder Secretary, STES

Secretary, Sinhgad Sport Club & Cultural Centre

Mr. Rohit M. Navale
 Vice. President (HR), STES
 Chairman, Sinhgad Sport Club & Cultural Centre

Director

S.K.N. Sinhgad School of Business Management
 S. No. 10/1, Ambegaon (BK), Pune - 411 041

4



Scanned by CamScanner

Sports and cultural activities / competitions organised at the institution level during the year

SKN Sinhgad School of Business Management

Activity (Sports)	Level	Number of
Table Tennis (Boys)	ter Colle	2
Table Tennis (Girls)		2
Table Tennis (Mixed doubles)		2
Cricket (Boys)		12
Cricket (Girls)		12
Football (Boys)		16
Football (Girls)		0
Volleyball (Boys)		8
Volleyball (Girls)		6
Basketball (Boys)		0
Basketball (Girls)		0
Lawn Tennis (Girls)		0
Lawn Tennis (Boys)		0
Lawn Tennis (Mixed Doubles)		0
Lawn Tennis (Boys - doubles)		0
Lawn Tennis (Girls - doubles)		0
Kabaddi(Boys)		12
Kabaddi (Girls)		0
Chess (Boys)		1
Chess (Girls)		0
Swimming (Boys)		0
Swimming (Girls)		0
Atheletics- Running (100 m)- Boys		3
Atheletics- Running (100 m)- Girls		3
Atheletics- Relay (4*100 m)- Girls		4



Director
S.K.N. Sinhgad School of Business Management
S. No. 10/1, Ambegaon (Bk), Pune - 411 041



S.K.N. Sinhgad School of Business Management
S. No. 10/1, Ambegaon (Bk), Pune - 411 041



Atheletics- Relay (4*100 m)- Boys	4
Badminton-Boys	1
Badminton-Girls	1

**SKN Sinhgad School of Business Management, S.No.10, Ambegaon (Bk.),
Pune-411041**

Sports Activity -

Students of SKN Sinhgad School of Business Management participate in various sports activities throughout the year for overall wellbeing. Students apart from academic do engage in the sports activity. Students use the playground of Sinhgad Institute.

Sinhgad karandak is the flagship sport event of Sinhgad institute. Various sports competitions are organised during the karandak. Students enthusiastically participate in it. Sinhgad karandak was organised from 7th–Jan-2020 to 31st–Jan-2020. Students registered for various sport event and participated in solo and team sports events.

Student participation of SKN SSBM Students in Sports karandak

Sports and cultural activities / competitions organised at the institution level during the year		
SKN Sinhgad School of Business Management		
Activity (Sports)	Level	Number of Participants
Table Tennis (Boys)	Inter College	2
Table Tennis (Girls)		2
Table Tennis (Mixed doubles)		2
Cricket (Boys)		12
Cricket (Girls)		12
Football (Boys)		16
Football (Girls)		0
Volleyball (Boys)		8
Volleyball (Girls)		6
Basketball (Boys)		0
Basketball (Girls)		0
Lawn Tennis (Girls)		0
Lawn Tennis (Boys)		0
Lawn Tennis (Mixed Doubles)		0
Lawn Tennis (Boys - doubles)		0
Lawn Tennis (Girls - doubles)		0
Kabaddi(Boys)		12
Kabaddi (Girls)		0
Chess (Boys)		1
Chess (Girls)		0
Swimming (Boys)		0
Swimming (Girls)		0
Atheletics- Running (100 m)- Boys		3
Atheletics- Running (100 m)- Girls		3
Atheletics- Relay (4*100 m)- Girls		4
Atheletics- Relay (4*100 m)- Boys		4

Director
 S.K.N. Sinhgad School of Business Management
 c. No. 10/1, Ambegaon (BK), Pune - 411 041



Badminton- Boys	1
Badminton- Girls	1

Objectives –

Sport activities are promoted and encouraged amongst the students for the holistic development of the students.

Outcome-

Students of SKN Sinhgad School of Business Management participated in various sports activities and competitions. It builds the competitive & team spirit amongst the students. It also helps them to maintain good health and develop the habit of self care.

Director

S.K.N. Sinhgad School of Business Management
S. No. 10/1, Ambegaon (BK), Pune - 411 041



1. The first part of the document is a list of names and addresses.

2. The second part of the document is a list of names and addresses.

3. The third part of the document is a list of names and addresses.

4. The fourth part of the document is a list of names and addresses.

5. The fifth part of the document is a list of names and addresses.

6. The sixth part of the document is a list of names and addresses.

7. The seventh part of the document is a list of names and addresses.

8. The eighth part of the document is a list of names and addresses.

19/10/2020

Sinhgad Technical Education Society Mail - Marketing Seminar 17-Oct-2017



pravin bodade <pravinbodade.sknsbm@sinhgad.edu>

Marketing Seminar 17-Oct-2017

1 message

pravin bodade <pravinbodade.sknsbm@sinhgad.edu>
To: FacultySKNSBM <facultysknsbm@sinhgad.edu>

15 October 2019 at 17:46

Dear All,

Please find attached, the Marketing seminar details scheduled on 17-Oct-2019

—

Regards
Pravin G. Bodade
S.K.N. Sinhgad School of Business Management
S.No.10, Ambegaon (Bk.), Pune-411041
(M)9890081231

2 attachments

Marketing Seminar- Emerging Technologies for customer centricity 17th-Oct-2019 (3).pdf
85K

Marketing Seminar SKNSBM-Letter (3).pdf
444K

Director

S.K.N. Sinhgad School of Business Management
S. No. 10/1, Ambegaon (BK), Pune - 411 041



<https://mail.google.com/mail/u/2?ik=f62fc6104e&view=pt&search=all&permthid=thread-a%3Ar2861431175368607178&simpl=msg-a%3Ar281350...> 1/1

Sinhgad Technical Education Society's
SKN Sinhgad School of Business Management, PUNE-41

Marketing Seminar Schedule

Title- "Emerging technologies for customer centricity"
Date-17-Oct-2019

Program schedule	Time	Resource person
1. Inauguration session & 2. Emerging Technologies for customer centric business approach	10 a.m. to 11.30 a.m.	Dr. Rajashree Shinde
		Mr. Devdatta Mandore
3. Customer centric technology adoption in Automobile Industry	11.45 a.m. to 1.15 p.m.	Mr. Rajshekhar Gubala
4. Poster Presentation 5. closing session	2.30 p.m. to 4.00 p.m.	Mr. Irfan siddique
		Dr. Rajashree Shinde



Director
S.K.N. Sinhgad School of Business Management
S. No. 10/1, Ambegaon (BK), Pune - 411 041



MARKETING SEMINAR & POSTER COMPETITION

Emerging Technologies for Customer Centricity

S.K.N. Sinhgad School of Business Management is established in the year 2010 under the aegis of Sinhgad Technical Education Society under the leadership of Prof. M. N. Navale and Dr. Mrs. Sunanda Navale. S.K.N. Sinhgad School of Business Management offers 2 yrs. fulltime MBA programme which is recognized by AICTE Delhi, affiliated to University of Pune and approved by Government of Maharashtra State.

SKNSSBM is organizing one day marketing seminar on "Emerging Technologies for Customer Centricity". Marketing seminar provides an understanding of evolving initiatives of Marketers to serve the customers in the best possible manner. The objective of this seminar is to create awareness about adoption of various technologies by the organizations to serve the customers and move ahead of the competition.

Details of the Program:

Sr.No.	Topic	Timing
1	Emerging Technologies for customer centric business approach	10 a.m. to 11.30 a.m.
2	Customer centric technology adoption in Automobile Industry	11.45 a.m. to 1.15 p.m.
3	Poster Presentation	2.30 p.m. to 4.00 p.m.

Date: - 17th October, 2019	Time: - 09:00 AM onwards	Venue: - Seminar Hall, Ground Floor
<i>For Registration Contact</i>	Prof. Yatin Bokil -8600996990 Dr. Rahul Wagh -7588053522 Dr. Ganesh Yadav -9922954775	Student Coordinator: Madhav Kamble- 9702750444

Registration fees *-Rs.50/

Prof. Pravin Bodade
Seminar Coordinator

Dr. Rajashree Shinde
Director



Director

S.K.N. Sinhgad School of Business Management
S. No. 10/1, Ambegaon (BK), Pune - 411 041



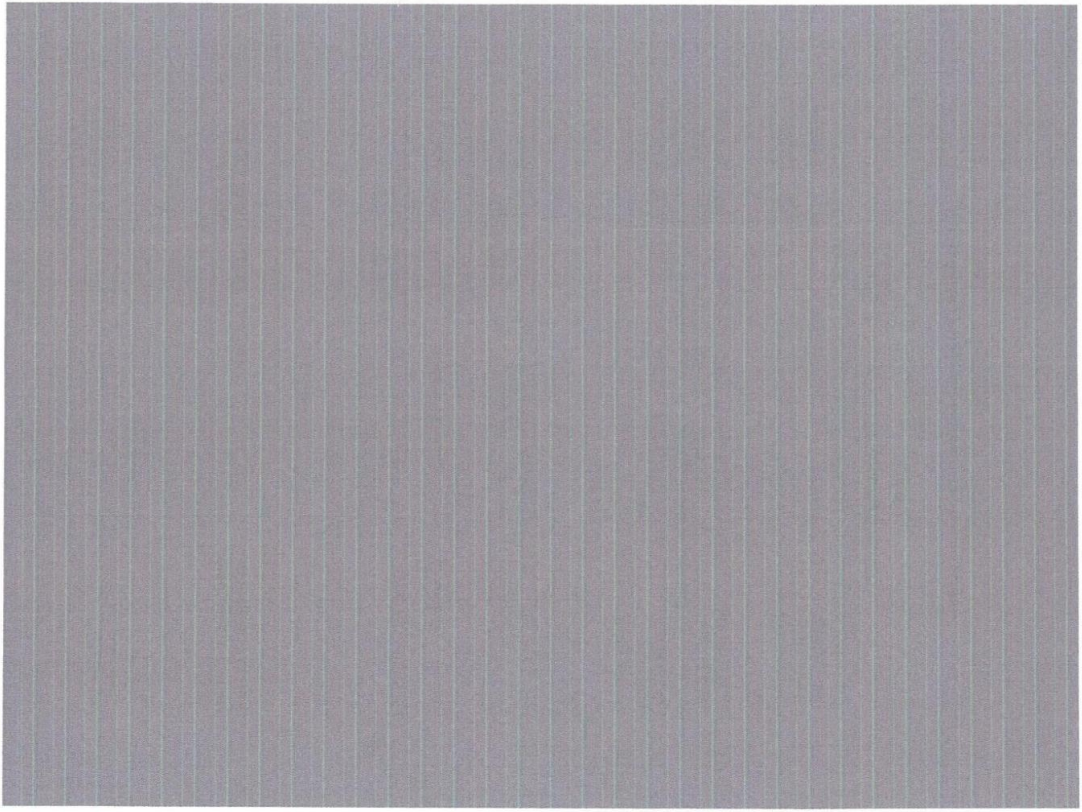

S.K.N.Sinhgad School of Business Management
REPORT OF ONE DAY MARKETING SEMINAR :
DATE : 17th OCT 2019

ACTIVITY TITLE: "EMERGING TECHNOLOGIES FOR CUSTOMER CENTRICITY"

NAME OF GUEST SPEAKER: MR. DEVDATTA MANDORE

DESIGNATION: ENTREPRENEUR, TRAINER CONSULTANT

ORGANIZATION NAME: Wbclincher.com

NAME OF THE GUEST SPEAKER: MR. RAJ SHEKHAR GUBBALA

DESIGNATION: TRAINING & DEVELOPMENT SPECIALIST

ORGANIZATION NAME: STRATEGIC LEARNING SOLUTIONS PVT.LTD

DATE: September 17th OCT 2019

DAY: Thursday

VENUE: Seminar Hall, SKNSSBM

TIME: 9:30 TO 4:00

CLASS: MBA-I

TOTAL NUMBERS OF PARTICIPANTS: 115

Description of Activity:

The honorable chief guest **MR. DEVDATTA MANDORE** started the session by giving an overview of the digital marketing and covered the concept of content marketing..

During session following points were discussed by giving suitable examples.

1. Introduction to content marketing
2. Discussed various case studies like Clear tax, Nisha Mudhulika etc
3. Discussed top youtube channels like techguruji, urbanfight etc
3. Importance of Digital Marketing
4. How to do content writing.
5. How to open an account for content writing and videos .
5. Discussion on tools like Blogger.com, Canva.com
5. Reasons of doing MBA and designation after MBA and its advantage

The lecture was full of knowledge as most of students were unaware of this procedure and its benefits.

The session was very informative for students because the topic selected by Mr. Devdatta Mandore was very technical and future oriented.

Director

S.K.N. Sinhgad School of Business Management
S. No. 10/1, Ambegaon (BK), Pune - 411 041



Description of Activity:

The honorable chief guest **Mr. Raj Shekhar Gubbala** started the session by giving an overview of the Automobile Industry and technology adoption
During session following points were discussed by giving suitable examples.

1. Overview of Automobile Industry
2. Technology adoptions in various companies like TATA,TOYOTA,MAHINDRA etc
3. Changing customers trends & demands.
4. Marketing process
5. Automobile Industry requirements from students

The session was very informative for students as Mr. Raj Shekhar Gubbala discussed about Automobile Industry and what skills this industry is looking from MBA students.

Description of Activity :

Poster Presentation: **Emerging Technologies for Customer Centricity**

Evaluator : Mr. IRFAN SIDDIQUE

Total Teams: 15

The Poster presentation activity was conducted on the topic Emerging Technologies for Customer Centricity. In all 15 teams have participated for this activity.

Winner Team : Topic- EMERGING TECHNOLOGIES FOR CUSTOMER CENTRICITY

Participants name: Mayur Dnyaneshwar Navhale, Abhishek Suryawanshi Patil, Abhishek Rajesh Suryawanshi

Runner up team : Topic- MOBLIE TECHNOLOGIES

Participants Name: Swapnil Kishor Gavali, Arshiya Ismail Shaikh, Kamble Mahadeo Bajirao

Director
S.K.N. Shrihgad School of Business Management
S. No. 10/1, Ambegaon (BK), Pune - 411 041



S.K.N. Sinhgad School of Business Management, Ambegaon (Bk)

Report on Induction Program 2019

16th September 2019

1st Day

The Induction program of SKNSSBM aimed to give the students who are joining the college a bird's eye view about various dimensions of Management study and the career opportunities for the Management students and to acquaint them with the systems and procedures of the college. The program aimed to give a proper orientation to the new students about the course, about Management and about the future prospects as well as the methodology of learning to be adopted to be successful in life.

Inaugural Session by - Chief Guest – Dr. Yogesh Kumar Upadhyay

The program was inaugurated by lighting of the lamp by the dignitaries and reciting of the Saraswati Vandana which was sung by MBA students. The inaugural session was chaired by the Chief Guest Dr. Yogesh K. Upadhyay, our Director Dr. Rajashree Shinde and Dean Prof. Yatin Bokil.



The inaugural session started with the address by our Director Dr. Rajashree Shinde, who showed the path to the students about the expectations of institute from them and also their responsibilities towards their career to match with the business world. She emphasized on how their aspirations will get converted into reality by their efforts and Institute's meticulous support. She stressed on Regularity, Sincerity, Hard work and Involvement of all the students in various activities organised for their total personality development.

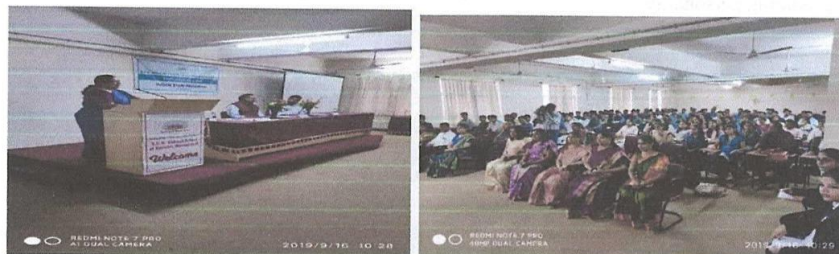

Director

S.K.N. Sinhgad School of Business Management
S. No. 10/1, Ambegaon (BK), Pune - 411 041





The Chief Guest Dr. Yogesh K.Upadhayay, Fellow and past president Indian Society for Training and development , Director Uthkrishtha Management Consultants Private Limited addressed the students. Both of them guided the students on bridging the gapbetween Academics and Industry. They shared their own experience, how they overcome their fear in industries to be successful with the help of ethics and values. Sir also highlighted various aspects of Soft skills , Communication Skills for grooming personality. It has been followed by Prize Distribution for best academic performance of MBA Second year Students in their last Academic year.



Session by – Key Note Speaker – Dr. Swapnil Dhayade (Managing Director, Varad Buildcon Pvt. Ltd.). Sir addressed the students from point of view of industry . Both of them guided the students on bridging the gap between Academics and Industry. He shared his own experience, he motivated students for becoming future manager and upcoming entrepreneur with ethics and values. Sir also highlighted various aspects of Soft skills , Communication Skills for grooming personality.



S.K.N.
 Director
 S.K.N. Sinhgad School of Business Management
 S. No. 10/1, Ambegaon (BK), Pune - 411 041



S-card Data collection



17th September 2019

2nd Day

Session by – Key Note Speaker- Dr. Prasanna Gadre (MBBS,DVD,DNB,MIAOH, Corporate HR and Health Trainer)10.00 am. – 11.15 am. He spoke on aspect of passion hard work, values, ethics and their contribution in development of human beings. He has focused on self-realisation, guided student on focus on career and future prospects in Corporate. How we can correlate our personal talent, interest with profession by giving examples.

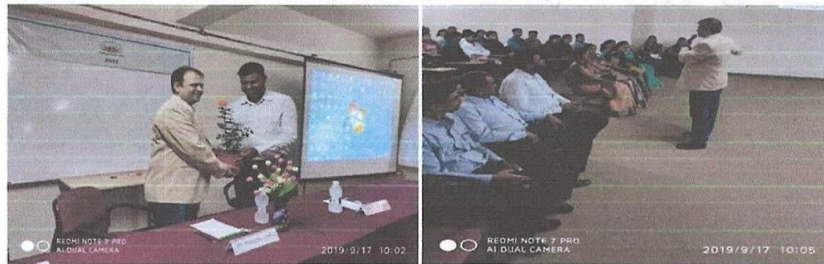

- Revised Syllabus Orientation:**
- 1. Dr. Shalaka Sakharekar**
 - 2. Dr. Sadhana Ogale**
 - 3. Prof. Manjula Dhulipala**

Dr. Shalaka Sakharekar And team of faculty guided students about revised syllabus, subjects, marking weightage, major and minor specialisation , importance of detailed studies of subject and evaluation process. Also Dr. Sadhana Ogale guided students for online portals LIKE SWAYAM for various additional courses and advantages of it and explained registration process as well.

Handwritten signature in purple ink.



Session by Alumni

Two alumni came Ms. Anjum Khoja and Ms. Swati Barodia for sharing their experiences of Industry and Academics. What all efforts they took for getting placed.



Briefing Session about Harvard / IIM Case Study Module

1. Dr. Rahul Wagh 2. Prof. RozaParashar

Both faculties guided on case studies, how we can take benefit of our online resources for case studies and how to solve them. It's importance in MBA. Roza madam explained that studies and their solutions are varies with different situations with an example.



Session on Sinhgad Students Council

Students got to know idea about Student council, members, process of membership and benefits after becoming member of Student council. Session is conducted by student council members.



Director

S.K.N. Sinhgad School of Business Management
S. No. 10/2, Ambegaon (BK), Pune - 411 041



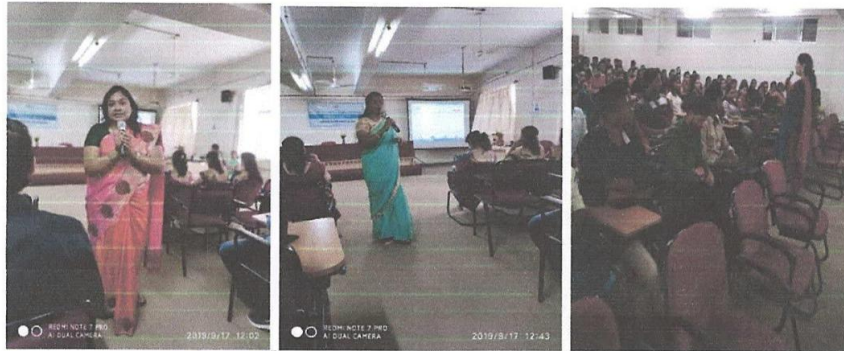

Session on Placement- Dr. Jayesh Minase (Dean, Central Placement Cell, Sinhgad Management Institutes)

Placement Session

During the session our placement Director, Sinhgad Dr. Jayesh Minase (Dean, Central Placement Cell, Sinhgad Management Institutes) addressed the students. He gave detailed information to students regarding the placement activities. At the end of placement session, Sir explained the rules and regulation to be followed while applying for a job through CPC.



This is followed by Placement Data Collection -2.30 pm – 4.30 pm and S-card Data Collection- 4.30 pm – 6.00 pm.

Director

S.K.N. Sinhgad School of Business Management
S. No. 10/1, Ambegaon (BK), Pune - 411 041



1995-1996
1997-1998
1999-2000

1995-1996
1997-1998
1999-2000

1995-1996
1997-1998
1999-2000

1995-1996
1997-1998
1999-2000

1995-1996
1997-1998
1999-2000

1995-1996
1997-1998
1999-2000

Report on Women's Day Celebrations

Topic	Women Health Awareness
Name Of Guest Speaker	Dr. Agawane Shubhangi Uttam
Degree	MBBS, M.D, DPH
Designation	Associate Professor
Organization Name	Department of Community Medicine, SKN MC & GH
Date & Day	9 th March 2020 & Monday
Time	9:00 AM - 4:30 PM
Venue	Seminar Hall 1, SKN Sinhgad School of Business Management
Class	MBA - First Year & Second Year
Total Number of Participants	

Summary of the celebrations

Women are a valuable part of our society; they play a very vital role in human progress. For a very long time, women were considered inferior to men. However, the role of a woman in society has significantly changed during recent decades.

To recognize the efforts of women; we celebrated Women's Day on 9th March, 2020 at SKN Sinhgad School of Business Management. The celebrations were divided into five parts;

Sr. No.	Time	Description
1	9:00 AM - 11:00 AM	Preparation of Rangoli & Poster Competitions
2	11:00 AM - 12:30 PM	Guest Lecture by Dr. Agawane Shubhangi Uttam
3	1:30 PM - 3.00 PM	Final preparation of Rangoli, Poster & Mehendi Competition
4	3:00 PM - 4:00 PM	Evaluation of all competitions
5	4:00 PM - 4:30 PM	Judgement of all competitions

First session started with the preparation of Rangoli & Poster. The theme for the competition was Women Health Awareness. Participants were provided with all the required materials for rangoli and poster. Initially, participants were given 2 hours for the preparation and after that they were required to attend the next session.

Second session started with the guest lecture on Women Health Awareness which was delivered by Dr. Agawane Shubhangi Uttam. She has completed her MBBS, M.D (Doctor of Medicine), DPH (Diploma of Public Health). She is working as an Associate Professor at Department of community medicine at SKN medical college, Pune. During her session she gave a lot of insights regarding women's health. She shared various tips to remain fit such as 30 minute exercise in the morning; yoga; morning & evening walks; eating healthy foods; regular body checkups etc. She gave a lot of precautionary measures which women must take during pregnancy and post pregnancy. The session was very much interactive and ended on a positive note.

Post second session everyone dispersed for lunch.

Director

S.K.N. Sinhgad School of Business Management
S. No. 10/3, Ambegaon (BK), Pune - 411 041



During third session participants were given final 90 minutes to complete the rangoli & poster. Mehendi competition also started in this session. Every participant was assigned a faculty member to whom mehendi was to be drawn. All the participants actively participated in these competitions.

During fourth session rangoli, poster & mehendi were evaluated by the judges. Every participant was given 5 minutes to explain the rangoli and poster. The mehendi was evaluated manually by the judges.

During fifth session winners were declared.

The overall celebrations were great. It was full of insights related to women's health and fun during the competitions.

Photos of the Session:

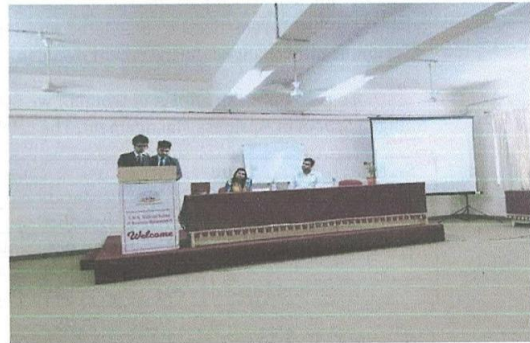

Director
S.K.N. Sinhgad School of Business Management
S. No. 10/1, Ambegaon (BK), Pune - 411 041



Report on Women's Day Celebrations

Topic	Women Health Awareness
Name Of Guest Speaker	Dr. Agawane Shubhangi Uttam
Degree	MBBS, M.D, DPH
Designation	Associate Professor
Organization Name	Department of Community Medicine, SKN MC & GH
Date & Day	9 th March 2020 & Monday
Time	9:00 AM - 4:30 PM
Venue	Seminar Hall 1, SKN Sinhgad School of Business Management
Class	MBA - First Year & Second Year
Total Number of Participants	

Summary of the celebrations

Women are a valuable part of our society; they play a very vital role in human progress. For a very long time, women were considered inferior to men. However, the role of a woman in society has significantly changed during recent decades.

To recognize the efforts of women; we celebrated Women's Day on 9th March, 2020 at SKN Sinhgad School of Business Management. The celebrations were divided into five parts;

Sr. No.	Time	Description
1	9:00 AM – 11:00 AM	Preparation of Rangoli & Poster Competitions
2	11:00 AM – 12:30 PM	Guest Lecture by Dr. Agawane Shubhangi Uttam
3	1:30 PM - 3,00 PM	Final preparation of Rangoli, Poster & Mehendi Competition
4	3:00 PM – 4:00 PM	Evaluation of all competitions
5	4:00 PM – 4:30 PM	Judgement of all competitions

First session started with the preparation of Rangoli & Poster. The theme for the competition was Women Health Awareness. Participants were provided with all the required materials for rangoli and poster. Initially, participants were given 2 hours for the preparation and after that they were required to attend the next session.

Second session started with the guest lecture on Women Health Awareness which was delivered by Dr. Agawane Shubhangi Uttam. She has completed her MBBS, M.D (Doctor of Medicine), DPH (Diploma of Public Health). She is working as an Associate Professor at Department of community medicine at SKN medical college, Pune. During her session she gave a lot of insights regarding women's health. She shared various tips to remain fit such as 30 minute exercise in the morning; yoga; morning & evening walks; eating healthy foods; regular body checkups etc. She gave a lot of precautionary measures which women must take during pregnancy and post pregnancy. The session was very much interactive and ended on a positive note.

Post second session everyone dispersed for lunch.

Director

S.K.N. Sinhgad School of Business Management
S. No. 18/3, Ambegaon (BK), Pune - 411 041





A handwritten signature in blue ink, likely belonging to the Director of the school.

Director

S.K.N. Sinhgad School of Business Management
S. No. 10/1, Ambegaon (BK), Pune - 411 041



Report On Guest Session

Topic	Road Safety
Name Of Guest Speaker	Mr. Rajesh Puranik
Designation	Sr. Police Inspector Traffic Department Pune City
Organization Name	Traffic Department ,Pune City
Contact No	
Date & Day	7.10.2019 & Monday
Time	11.00AM – 1.00PM
Venue	Seminar Hall 1, SKN Sinhgad School of Business Management
Class	MBA - First Year
Total Number of Participants	180

Summary of the Session

Mr. Rajesh Puranik was facilitated by Dr Rajashree Shinde. He started the session by sharing his experiences about how Indian people are in the habit of not following traffic rules. He played videos on the difference in the attitude of persons in European countries and in India regarding traffic rules. His team circulated various pamphlets regarding traffic norms and make the learning interesting. At the end there was question answer session.



Director

S.K.N. Sinhgad School of Business Management
S. No. 10/1, Ambegaon (BK), Pune - 411 041

Photographs





Handwritten signature

Director

S.K.N. Sinhgad School of Business Management
No. 10/1, Ambegaon (BK), Pune - 411 041



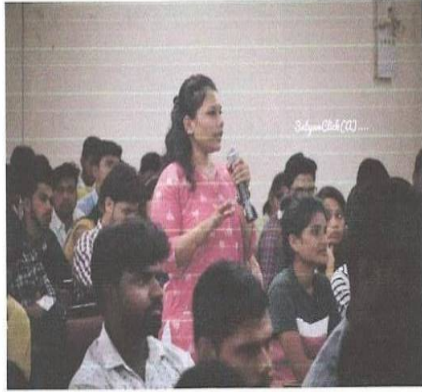

Faint, illegible text in the upper right corner of the page.

Director
S.K.N. Sinhgad School of Business Management
S. No. 10/1, Ambegaon (BK), Pune - 411 041



कार्यक्रमाचा अहवाल

कार्यक्रमाचे नाव	मराठी भाषा संवर्धन पंधरवडा निमित्त व्याख्यान व विविध स्पर्धा
प्रमुख पाहुणे	श्री. अनिल गोरे सर
पदनाम	मार्गदर्शक आणि वक्ते
तारीख आणि वार	१५-०१-२०२० & बुधवार
वेळ	१२.०० ते १.००
स्थळ	सेमिनार हॉल १, SKN सिंगड स्कूल ऑफ बिझनेस मॅनेजमेन्ट
वर्ग	MBA - १
एकूण उपस्थित विद्यार्थी	१००

कार्यक्रमाची प्रास्ताविका

कार्यक्रमाची सुरुवात प्रमुख पाहुणे श्री. अनिल गोरे सर यांच्या हस्ते झाली. सौ.राजश्री शिंदे मॅडमनी मराठी भाषेचे महत्व थोडक्यात विद्यार्थ्यांसमोर मांडले. त्यानंतर श्री. अनिल गोरे सरानी विद्यार्थ्यांना मार्गदर्शन केले. त्यांचे मराठी भाषेतील योगदान स्फूर्तिदायक आणि वाखाणण्याजोगे आहे.मागील पाच वर्षात सुमारे दोन लाख पालकांना पाल्याचे शिक्षण मराठी माध्यमातून घेण्यासाठी प्रवृत्त केले आणि त्या संदर्भात मार्गदर्शन केले.

भाषणातील महत्वाचे मुद्दे-

-मराठी भाषेचा उगम.

-मराठी हि जगातील १०व्या क्रमांकाची भाषा आहे.

-मराठी भाषेतील स्वर आणि व्यंजने यांच्याविषयी माहिती.

-उच्चशिक्षण इंग्रजी भाषेमध्ये असले तरीही मराठी हि आपली प्रथम भाषा आहे.

-मराठी हि इंग्रजी इतकीच महत्वाची आहे.

-विविध उदाहरणे आणि कथांमधून मराठी भाषेचे महत्व मांडले.

-मराठी भाषांतर मंडळांमधून उत्पन्न हि मिळते हे सुचवले.

मराठी भाषा संवर्धन निमित्त विविध स्पर्धा-

मराठी भाषा संवर्धन दिनानिमित्त मागच्या पंधरा दिवसांपासून वेगवेगळ्या स्पर्धांचे आयोजन करण्यात आले. या स्पर्धांमध्ये अनेक मुलांनी सहभाग घेतला.



Director

S.K.N. Sinhgad School of Business Management
S. No. 10/1, Ambegaon (BK), Pune - 411 041



०६-०१-२०२०	प्रश्नमंजुषा स्पर्धा	(विजेता - नदीम शेख)
०८-०१-२०२०	वादविवाद स्पर्धा	(विजेते- शिवानी कुलकर्णी , धनश्री अलोणे ,महादेव Sकांबळे,अभयसिंग पाटील)
१०-०१-२०२०	भाषण स्पर्धा	(विजेती- जागृती चव्हाण)
१३-०१-२०२०	हस्ताक्षर स्पर्धा	(विजेती- शिवानी कुलकर्णी)
१५-०१-२०२०	वेशभूषा स्पर्धा	(विजेती- नुपुरा वाळूगकर)

Kade

Director

S.K.N. Sinhgad School of Business Management
S. No. 10/1, Ambegaon (BK), Pune - 411 041

